

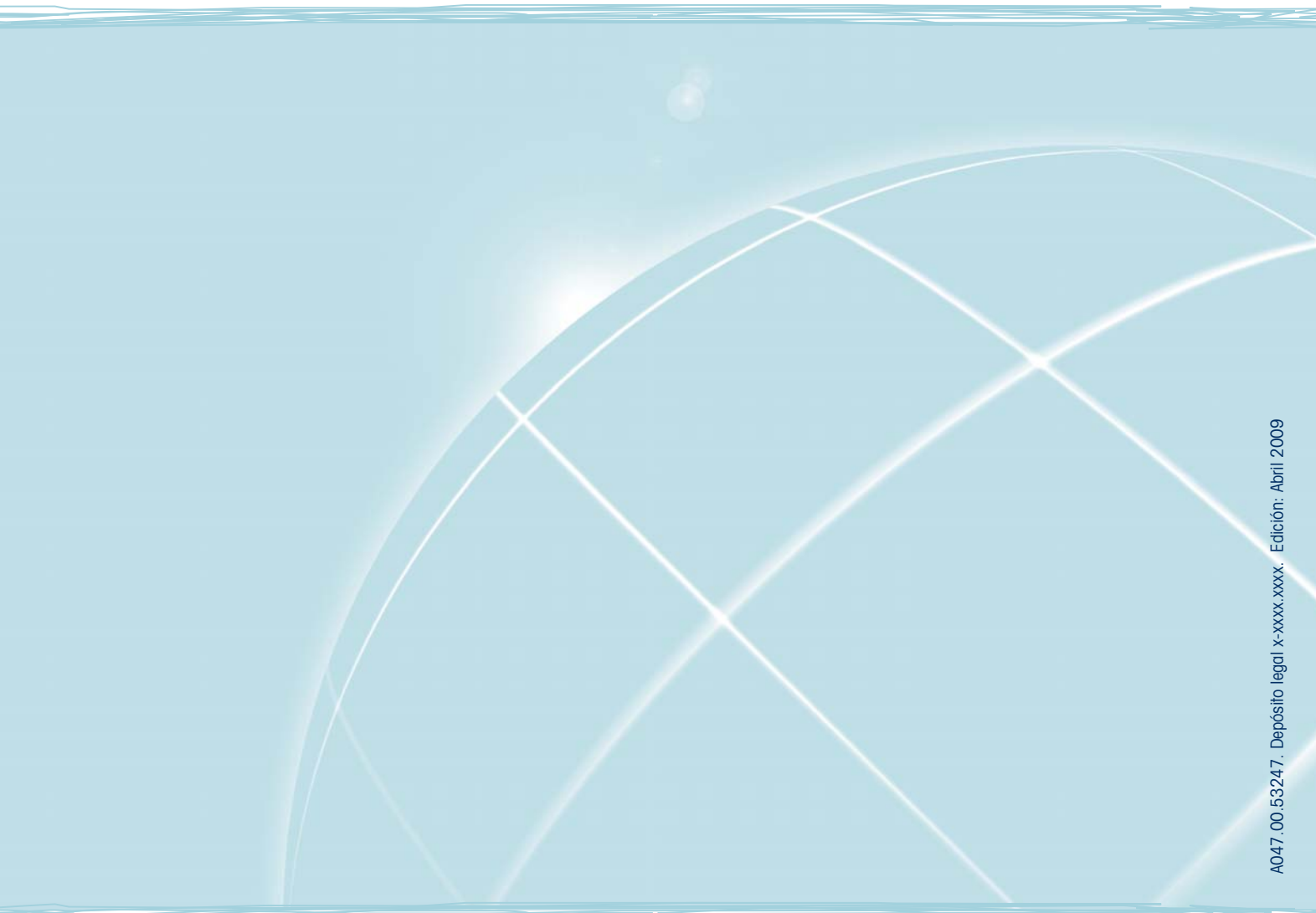

ORBIS TECNOLOGÍA ELÉCTRICA, S.A.  
Lérida, 61. E-28020 MADRID  
Tel.: +34 91 567 22 77  
Fax: +34 91 571 40 06  
www.orbis.es • info@orbis.es



energía inteligente®



A047.00.53247. Depósito legal x-xxxx.xxxx. Edición: Abril 2009



DISTRIBUTOR:

# General Catalogue

orbis.es

- › INSTALLATION AND CONTROL
- › MEASUREMENT AND ENERGY
- › CLIMATE AND COMFORT
- › STREET LIGHTING
- › INSTRUMENTATION





## CONTENTS

PAGE

• MODULAR TIME SWITCHES .....	4
• ANALOG TIME SWITCHES .....	5
• DIGITAL TIME SWITCHES .....	6
• CONTROL UNITS FOR HOUSEHOLD APPLICATIONS .....	8
• PLUG-IN TIMERS .....	10
• TOKENS OR COINS TIME COUNTER .....	11
• INDUSTRIAL TIME SWITCHES .....	12
• STAIRCASE TIME SWITCHES .....	13
• MOTION SENSOR SWITCHES .....	15
• DOOR BELLS / HOUR COUNTER .....	19
• LEVEL CONTROL RELAY / DISCONNECTOR PHASE .....	20

## MEASUREMENT AND ENERGY

PAGE

• SINGLE PHASE MODULAR ENERGY METERS .....	21
• THREE PHASES MODULAR ENERGY METERS .....	23
• TARIFF ENERGY METER-SINGLE PHASE .....	24
• MULTIFUNCTION ENERGY METER-SINGLE PHASE .....	25
• MULTIFUNCTION ENERGY METER-THREE PHASES .....	26
• METERS ACCESSORIES / LOAD MANAGER .....	27

## CLIMATE AND COMFORT

PAGE

• ANALOG THERMOSTATS .....	28
• ELECTRONIC THERMOSTATS .....	29
• CRONOTHERMOSTATS .....	30
• TELEPHONE CONTROLLERS .....	32
• THERMOSTATS AND CRONOTHERMOSTATS ACCESSORIES .....	33
• GAS DETECTOR .....	34

## STREET LIGHTING

PAGE

• TWILIGHT SWITCHES .....	35
• ASTRONOMIC TIME SWITCHES .....	36
• FLOW STABILIZERS – DIMMERS .....	37
• REMOTE MANAGEMENT SYSTEMS .....	40

## INSTRUMENTATION

PAGE

• DIGITAL VOLTMETERS / AMPMETERS AND FREQUENCYMETERS .....	42
• MODULAR NET ANALIZER .....	43
• THREE PHASES NET ANALIZER .....	44

# MODULAR TIME SWITCHES

## UNO



## INCA DUO



## SUPRA



## SUPRA (2 spheres)



### Description

Modular time switches to timer circuits such as illumination, acclimatization, pumps, etc. DIN rail mounting.

### Features

<b>Battery back-up</b>	<b>D:</b> No reserve <b>QRD and QRS:</b> 100 hours minimum	<b>D:</b> No reserve <b>QRD and QRS:</b> 100 hours minimum	<b>D:</b> No reserve <b>QRD y QRS:</b> 100 hours minimum Interchangeable battery	<b>QRDD and QRDS:</b> 100 hours minimum
<b>Dial / minimum switching time</b>	<b>D and QRD:</b> Daily/15 min.. <b>QRS:</b> Weekly 2 hours	<b>D and QRD:</b> Daily /15 min. <b>QRS:</b> Weekly 2 hours	<b>D y QRD:</b> Daily /15 min. <b>QRS:</b> Weekly 2 hours	<b>QRDD:</b> Daily-Daily/30 min.-30 min. <b>QRSD:</b> Weekly-Daily / 4 hours 30 min.
<b>Rated voltage</b>	120 or 230 Va.c. 12, 24 or 48 Va.c. / d.c.	120 or 230 Va.c. 12, 24 or 48 Va.c. / d.c.	120 or 230 Va.c. 12, 24 or 48 Va.c. / d.c.	120 or 230 Va.c. 12, 24 or 48 Va.c. / d.c.
<b>Frequency</b>	50/60 Hz	50/60 Hz	50/60 Hz	<b>QRDD and QRDS:</b> 50/60 Hz
<b>Switching capacity</b>	16 (4) A / 250 Va.c.	16 (4) A / 250 Vc.a.	16 (4) A / 250 Va.c.	2 x 16 (4) A / 250 Va.c.
<b>Contact</b>	Single	Conmutado	Changeover	2 x Changeover
<b>Maxim. recommended load</b>				
Incandescent	3000 W	3000 W	2000 W	3000 W
Fluorescent	500 W	500 W	500 W	500 W
Low voltage halogen	2250 VA	2250 VA	1000 VA	2250 VA
Halogen (230 Va.c.)	3000 W	3000 W	2000 W	3000 W
Low consumption lamps	500 W	500 W	400 W	500 W
<b>Own consumption</b>	0,5 W	0,5 W	0,5 W	0,5 W
<b>Operating temperature</b>	-10°C to +45°C	-10°C to +45°C	-10°C to +50°C	-10°C to +50°C
<b>Installation</b>	DIN rail	DIN rail	DIN rail	DIN rail
<b>Type of protection</b>	IP 20	IP 20	IP 20	IP 20

### Connection diagram

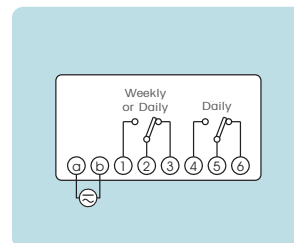
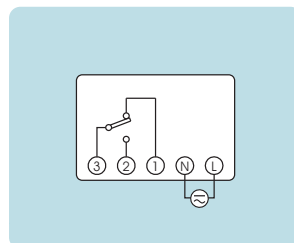
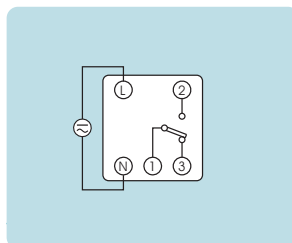
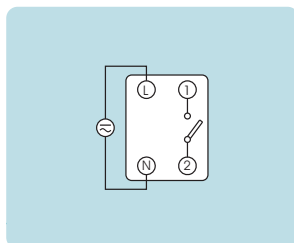

### Dimensions

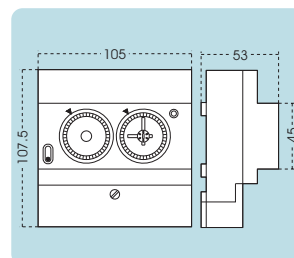
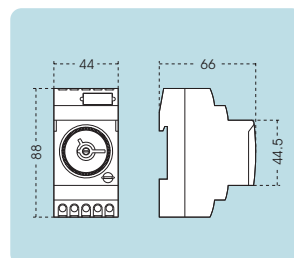
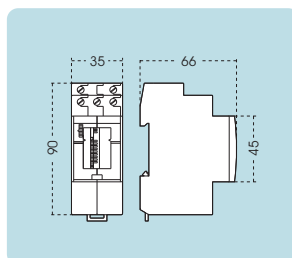
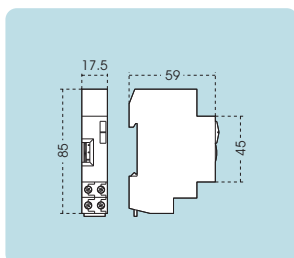

# ANALOG TIME SWITCHES

## CRONO



## ALPHA



## MINI T



### Description

Analog time switches to timer circuits such as illumination, acclimatization, pumps, etc. DIN rail, Surface or Panel mounting.

### Features

<b>Battery back-up</b>	<b>QRD, QRDD and QRSD:</b> 100 hours minimum Other models without battery back-up on request.	<b>D and S:</b> No reserve <b>QRD and QRS:</b> 100 hours minimum	<b>D:</b> No reserve <b>QRD and QRS:</b> 100 hours minimum
<b>Dial / minimum switching time</b>	<b>QRD:</b> Daily-15 min. <b>QRDD:</b> 2Daily-15 min. / 30 min. <b>QRSD:</b> Weekly-2 hours / Daily-30 min.	<b>D:</b> Daily /15 min. <b>S:</b> Weekly / 2 hours <b>QRD:</b> Daily /15 min. <b>QRS:</b> Weekly / 2 hours	<b>D:</b> Daily /15 min. <b>QRS:</b> Weekly / 2 hours
<b>Rated voltage</b>	120 or 230 Va.c.	<b>D and S:</b> 120 or 230 Va.c. <b>QRD/QRS:</b> 120 or 230 Va.c. 6, 12, 24 or 48 Va.c. / d.c.	<b>D and QRD:</b> 120 or 230 Va.c. <b>QRD/QRS:</b> 120 or 230 Va.c. 6, 12, 24 or 48 Va.c. / d.c.
<b>Frequency</b>	12, 24 or 48 Va.c. / d.c.	<b>D and S:</b> 50 or 60 Hz <b>QRD and QRS:</b> 45/60 Hz	<b>D:</b> 50 or 60 Hz <b>QRD and QRS:</b> 50/60 Hz
<b>Switching capacity</b>	<b>QRD:</b> 16(4) A / 250 V; <b>QRDD and QRSD:</b> 2x16(4) A / 250 Va.c.	16 (4) A / 250 Va.c.	16 (4) A / 250 Va.c.
<b>Contact</b>	<b>QRD:</b> 1 Changeover <b>QRDD and QRSD:</b> 2 Changeovers	Changeover	Changeover
<b>Maxim. recommended load</b>			
Incandescent	3000 W	3000 W	3000 W
Fluorescent	500 W	500 W	500 W
Low voltage halogen	2250 VA	2250 VA	2250 VA
Halogen (230 Va.c.)	3000 W	3000 W	3000 W
Low consumption lamps	500 W	500 W	500 W
<b>Own consumption</b>	0,8 W	0,8 W	1,8 W
<b>Operating temperature</b>	-10°C and +50°C	-10°C to +50°C	<b>D:</b> 0°C to +55°C; <b>QRD and QRS:</b> -10°C to +45°C
<b>Installation</b>	DIN rail - Surface - Panel mounting (Faston connexions)	DIN rail - Surface - Flush mounting (Faston connexions)	<b>MINI:</b> DIN rail - Surface (sealable terminals). <b>MINI T:</b> DIN rail - Surface - Flush mounting (Faston connex.).
<b>Protection type</b>	IP 20	IP 20	IP 20

### Connection diagram

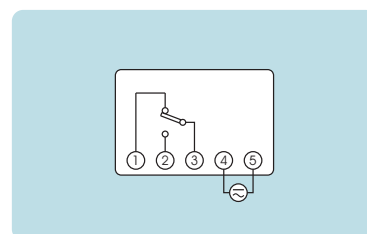
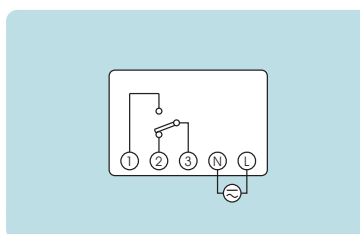
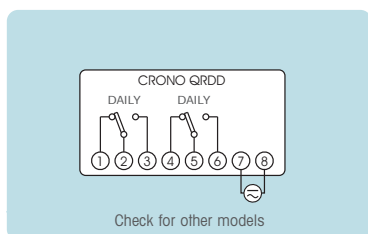

### Dimensions

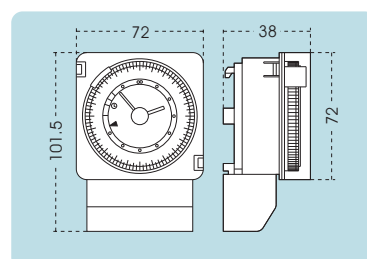
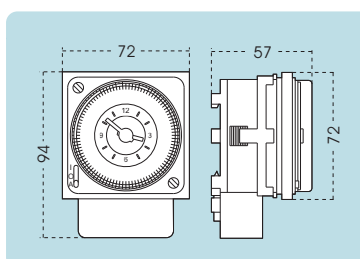
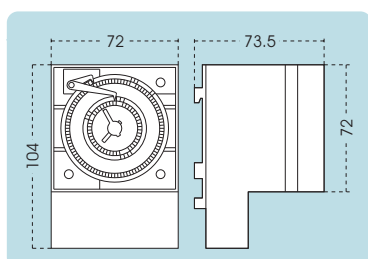



# DIGITAL TIME SWITCHES

## DATA MICRO + / DATA MICRO 2+



## DATA LOG / DATA LOG 2



## MINI T LOG



### Description

Modular time switches to timing electric circuits with programs by seconds, pulses, cycles, holiday period, running hour counter, etc. DIN, surface and panel mounting.

### Features

<b>Battery back-up</b>	4 years without power supply	5 years without power supply	5 years without power supply
<b>Memory spaces</b>	32 (programming by icon menus)	50 (programming by text menus)	50 (programming by text menus)
<b>Minimum switching time</b>	On/Off program: 1 min. Pulse program: 1s	On/Off program: 1 min. Pulse program: 1s	On/Off program: 1 min. Pulse program: 1s
<b>Programme</b>	Daily – Weekly Pulse program (from 1 to 59 seconds), holidays and winter/summer automatic change.	Daily – Weekly. Pulse program (from 1 to 59 seconds), cycles, holidays and winter/summer automatic change, random and running hour counter.	Daily – Weekly. Pulse program (from 1 to 59 seconds), cycles, holidays and winter/summer automatic change, random and running hour counter.
<b>Rated voltage</b>	120 or 230 Va.c. 12, 24 or 48 Va.c. / d.c. 50-60 Hz	120 or 230 Va.c. 12, 24 or 48 Va.c. / d.c. 50-60 Hz	120 or 230 Va.c. 12, 24 or 48 Va.c. / d.c. 50-60 Hz
<b>Switching capacity</b>	<b>DATA MICRO +:</b> 16(10) A / 250 Va.c. <b>DATA MICRO 2+:</b> 2x16(10) A / 250 Va.c.	<b>DATA LOG:</b> 16(10) A / 250 Va.c. <b>DATA LOG 2:</b> 2x16(10) A / 250 Va.c.	16(4) A / 250 Va.c.
<b>Contact</b>	<b>DATA MICRO +:</b> Changeover <b>DATA MICRO 2+:</b> 2 x Changeover	<b>DATA LOG:</b> Changeover <b>DATA LOG 2:</b> 2 x Changeover	Changeover
<b>Maximum recommended load</b>			
Incandescent	3000 W	3000 W	1000 W
Non-compensated	1200 W	1200 W	500 W
Compensated fluorescent	1200 W 150 µF	1200 W 150 µF	By means of contactor
Low voltage halogen	1000 VA	1000 VA	500 VA
Halogen (230 Va.c.)	2500 W	2500 W	1000 W
Low consumption lamps	200 W	230 W	By means of contactor
<b>Own consumption</b>	6 VA (1 W approx.)	6 VA Capacitive (1 W approx.)	6 VA Capacitive
<b>Operating temperature</b>	-10°C to +45°C	-10°C to +45°C	-10°C to +45°C
<b>Installation</b>	DIN Rail	DIN Rail	<b>MINI LOG:</b> DIN rail - Surface (sealable terminals). <b>MINI T LOG:</b> DIN rail - Surface - Flush mounting (Faston connexions).
<b>Protection type</b>	IP 20	IP 20	IP 20 / IP 51

### Connection diagram

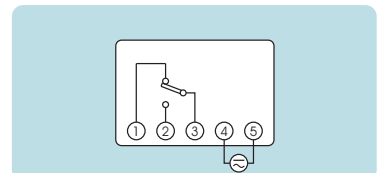
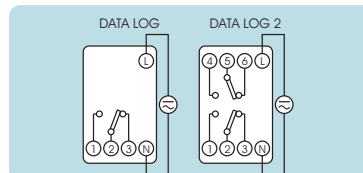
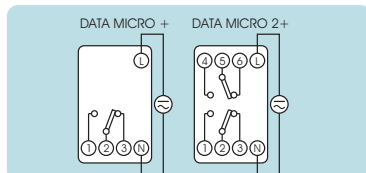

### Dimensions

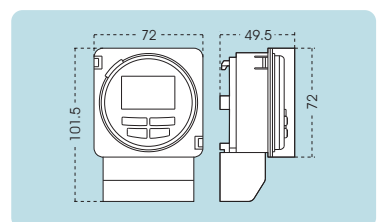
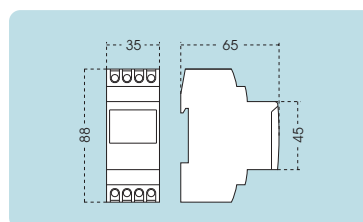
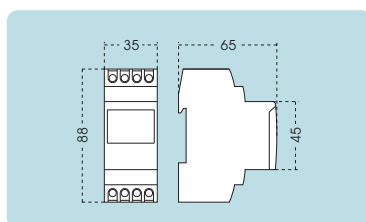



# DIGITAL TIME SWITCHES

## DATA MULTI ANUAL

## DATA ANUAL



### > Description

Digital time switches with daily, weekly, monthly and annual programming.  
DIN rail mounting

### > Features

Battery back-up	5 years without power supply	5 years without power supply
Memory spaces	100	50
Minimum switching time	1 sec.	1 sec.
Programming	Daily-weekly-monthly and annual. Configurable pulse program (1 to 59 sec.)	Daily-weekly-monthly and annual. Configurable pulse program (1 to 59 sec.)
Rated voltage	230 Va.c. / 24 Va.c. / d.c.	230 Va.c.
Switching capacity	4 x 16(10) A / 250 Va.c.	2 x 16(10) A / 250 Va.c.
Maximum recommended load		
Incandescent	1500 W	1500 W
Non-compensated fluorescent	600 W	600 W
Own consumption	3 VA approx.	8 VA approx.
Operating temperature	0°C to +50°C	0°C to +50°C
Installation	DIN Rail	DIN Rail
Protection type	IP 20	IP 20

### Connection diagram

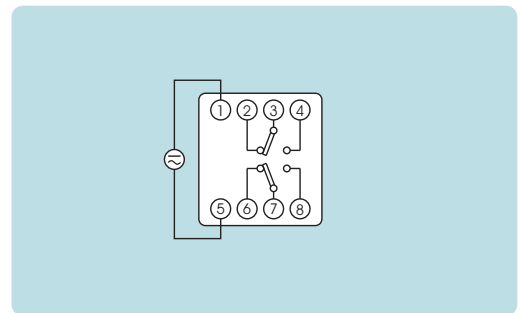
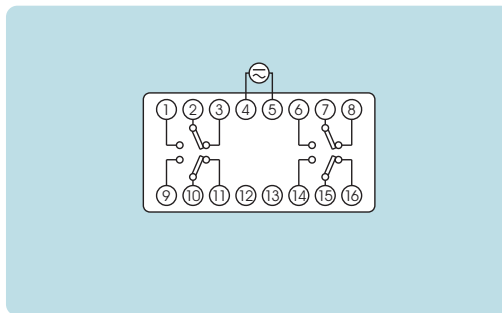

### Dimensions

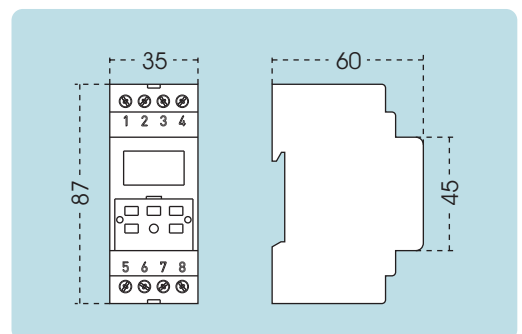
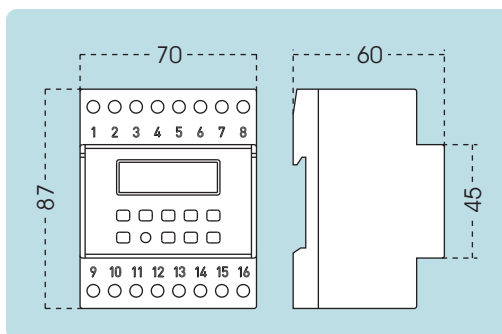

# CONTROL UNITS - FLUSH MOUNTING

## ILUMATIC 248



## ILUMATIC 348



## ROLLMATIC



### > Description

ANALOG devices to timing circuits such as lighting, blinds, etc. They are easy to install and programmable by means of pins.

### > Features

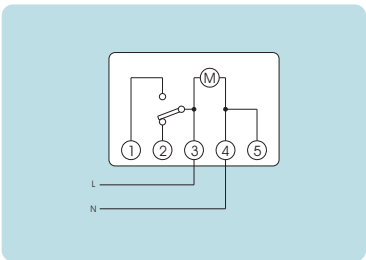
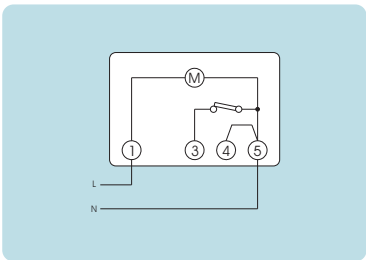
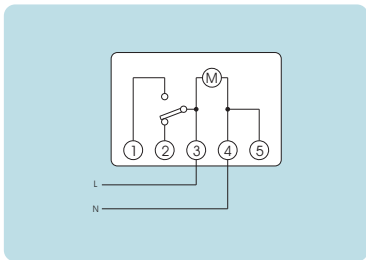
Rated voltage	230 Va.c. / 50 Hz	230 Va.c. / 50 Hz	230 Va.c. / 50 Hz
Switching capacity	10(4) A / 230 Va.c.	10(4) A / 230 Va.c.	10(2) A / 230 Va.c.
Own consumption	1, 6 VA	1, 6 VA	1, 6 VA
Maximum recommended load	2200 W	2200 W	2200 W
Manual control	ON - OFF - Automatic	ON - OFF - Automatic	Up - Stop - Down Automatic - OFF - Manual
Action	Programmable time switch	Programmable time switch	Programmable time switch for awnings, blinds, etc.
Sphere	<b>D (daily):</b> 24 hours <b>S (weekly):</b> 7 days	<b>D (daily):</b> 24 hours <b>S (weekly):</b> 7 days	<b>D (daily):</b> 24 hours <b>S (weekly):</b> 7 days
Minimum time operation	<b>D (daily):</b> 30 min. <b>S (weekly):</b> 1 h. 45 min.	<b>D (daily):</b> 30 min. <b>S (weekly):</b> 1 h. 45 min.	<b>D (daily):</b> 30 min. <b>S (weekly):</b> 1 h. 45 min.
Installation	Mechanism box	Mechanism box	Mechanism box
Protection type	IP 20	IP 20	IP 20
Connexion diagram			

### Dimensions

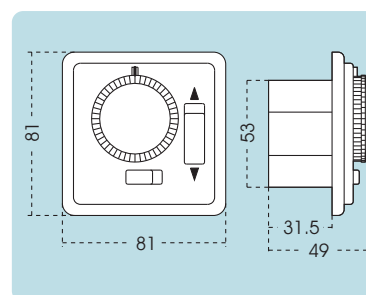
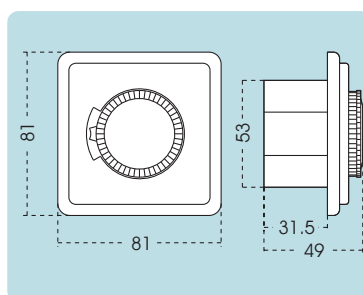
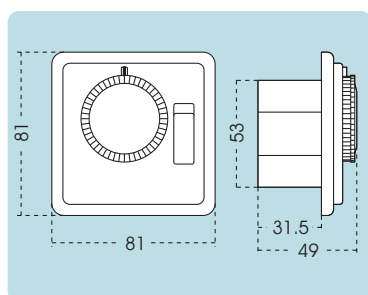

# CONTROL UNITS - FLUSH MOUNTING

ALARM CLOCK  
**DECO-TEMPO**



THERMOSTAT  
**DECO-TERMO**



CRONOTHERMOSTAT  
**DECO-CRONO**



BLINDS CONTROLLER  
**DECO-ROLL**



TIME SWITCH  
**DECO-DATA**



## Description

Build in devices for mechanism box and digital programming. Different models: alarm clock, thermostat, cronothermostat, time switch and blind controller.

## Features

<b>Nominal voltage</b>	230 Va.c.	230 Va.c.	230 Va.c.	230 Va.c.	230 Va.c.
<b>Frequency</b>	50 Hz	50 Hz	50 Hz	50 Hz	50 Hz
<b>Own consumption</b>	16, 5 VA maximum capacitive	16, 5 VA maximum capacitive	16, 5 VA maximum capacitive	16, 5 VA maximum capacitive	16, 5 VA maximum capacitive
<b>Switching capacity</b>	-	8 (2) A / 250 Va.c.	8 (2) A / 250 Va.c.	2x 5 (1) A / 250 Va.c.	8 (2) A / 250 Va.c.
<b>Battery backup</b>	24 h. by means of super condenser	24 h. By means of super condenser	24 h. By means of super condenser	24 h. By means of super condenser	24 h. By means of super condenser
<b>Operating temperature</b>	0 °C to + 40 °C	0 °C to + 40 °C	0 °C to + 40 °C	0 °C to + 40 °C	0 °C to + 40 °C
<b>Accuracy</b>	1sg/24h to 23° C Quartz clock	1sg/24h to 23° C Quartz clock	1sg/24h to 23° C Quartz clock	1sg/24h to 23° C Quartz clock	1sg/24h to 23° C Quartz clock
<b>Protection class</b>	II according to EN 60335	II according to EN 60335	II according to EN 60335	II according to EN 60335	II according to EN 60335
<b>Protection type</b>	IP 20	IP 20	IP 20	IP 20	IP 20
<b>Installation</b>	Universal mechanism box	Universal mechanism box	Universal mechanism box	Universal mechanism box	Universal mechanism box
<b>Features</b>	Date and time information. Alarm clock for domestic or hotel applications.	Heating and air conditioning control with two programmable temperature levels.	Air conditioning and heating systems control, two temperatures.	Device for arising and lowering the blinds.	Automatization of circuits such as lighting, irrigation, etc.
<b>Functions</b>	Two alarms with or without rearmament, countdown. Holiday period. Backlight contrast adjustable. Languages: Spanish, English and Portuguese.	Thermostat function. Comfort, power saver and anti ice temperatures. Air conditioning or heating operation. Holiday program. Languages: Spanish, English and Portuguese	Comfort, power saver and anti ice temperatures. 8 programs + thermostat. Holiday program. Languages: Spanish, English and Portuguese.	Automatic or manual control by pulses or directly. Up to 20 manoeuvres. Randomly manoeuvres to presence pretend and holiday program. Languages: Spanish, English and Portuguese.	Automatic or manual control. Up to 20 manoeuvres. Minimum operation time 20 seconds, Holiday and randomly programming. Languages: Spanish, English and Portuguese.

## Connexions

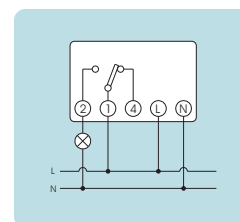
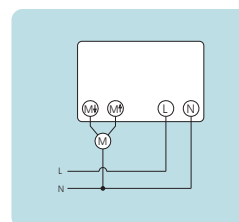
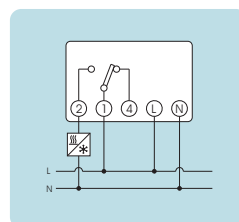
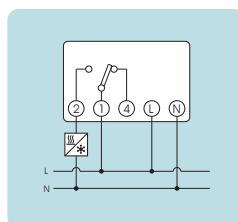
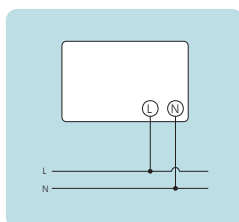

## Dimensions

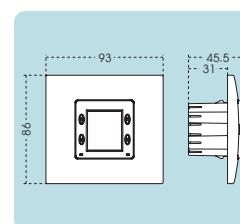
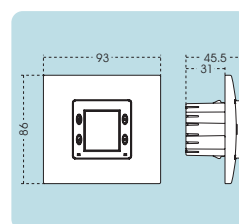
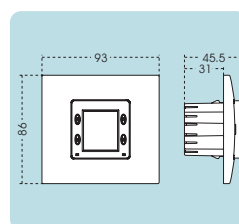
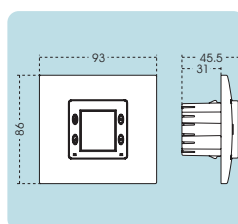
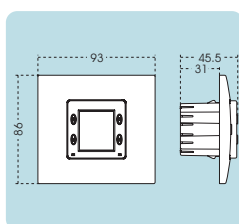



# PLUG-IN TIMERS

## CONTROL



## DOMO / DOMO / INTEMPERIE



## TEMPO +



### > Description

Timer switch for plug in devices, are useful in offices or domestic applications. Analogue, digital and even water prove models.

### > Features

Nominal voltage	230 Va.c. / 50Hz.	230 Va.c. / 50Hz.	120 or 230 Va.c. / 24 or 48 Va.c. /d.c. / 50-60 Hz
Switching capacity	16(4) A 230 Va.c.	16(4) A 230 Va.c.	16(10) A / 230 Va.c. $\cos \varphi = 1$
Battery backup	Without battery back up	Without battery back up	1 year without battery (Lithium CR2032)
Contact	-	-	AgSnO <sub>2</sub> Changeover
Own consumption	1, 6 VA (1, 5 W approx.)	1, 6 VA (1, 5 W approx.)	6 VA (1W approx)
Memory spaces	-	-	32
Maximum recommended load			
Incandescent	3500 W	3500 W	3000 W
Non-compensated fluorescent	Not suitable	Not suitable	1200 W
Fluorescents	Not suitable	Not suitable	180 W
Low voltage halogen	2250 VA	2250 VA	1000 VA
Halogen (230 Va.c.)	3500 W	3500 W	2500 W
Low consumption lamps	No suitable	No suitable	200 W
Accuracy	Depends on the net frequency	Depends on the net frequency	< ± 1 s/day to 23 °C
Programming	Lateral sphere D T15 - D T30: Daily S: Weekly	Front sphere D T15 - D T30: Daily S: Weekly M-60 - M 150 - M 900: Countdown	Digital Pulse programming (1 to 59 s), cycles, holiday, change s/w.
Minimum operation time	D T15: 15 min. D T30: 30 min. S: 1 h.-45 min.	D T15: 15 min. D T30: 30 min. S: 1 h. 45 min. M 60: 0-60 min. M 150: 0-150 min. M 900: 0-900 min.	1 second
Manual control	Automatic - Off - On	Automatic - Off - On	Automatic-Off-On
Model for outside	No	Domo Intemperie D T15, D T30 and S	No
Installation	Schuko 4, 8 mm socket type	Schuko 4, 8 mm socket type	Schuko 4, 8 mm socket type
Protection type	IP 20	IP 20 (IP 24 outdoor models)	IP 20
Operating temperature	0°C to +60°C	0°C to +60°C	-10 °C to +45 °C
Features	Children protection	Children protection	Children protection

### Dimensions

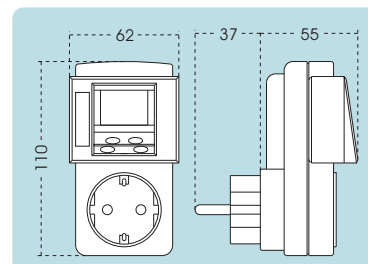
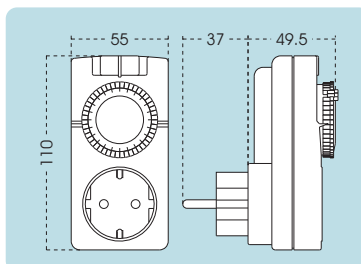
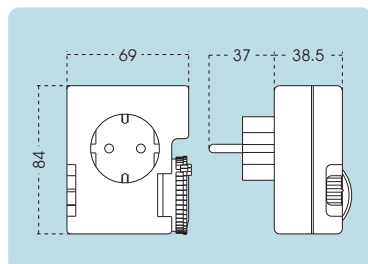

# TOKENS OR COINS TIME COUNTER

## CTM



## CTM ELECT. BÁSICO



## CTM ELECTRÓNICO



### Description

Timing of circuits by coins or tokens. Sport courts lighting in residences, washing machines in camp grounds, marinas, etc

### Features

Rated voltage	24, 120 or 230 Va.c. / 50Hz	12, 24, 48, 120 or 230 Va.c. / 45-60Hz	12, 24, 48, 120 or 230 Va.c. / 45-60Hz
Switching capacity	6(2) A / 250 Va.c.	10(2) A / 250 Va.c.	16(4) A / 250 Va.c.
Own consumption	2, 2 VA	5 VA	5 VA
Temporization memory	-	1 year	10 minutes
Operating accuracy	Depends of mains frequency	±0, 2%	±0, 2%
Operating temperature	-10 °C to +45 °C	-10 °C to +45 °C	-20 °C to +55 °C
Temporization per coin or tokens	1', 2', 3', 5', 10', 15', 30', 60', 90' ó 120' (on demand)	Programmable from 1 min. to 150 hours	Programmable from 1 min. to 150 hours
Special temporization	No	No	Yes
Time ending advice	Optional	Yes	Yes
Protection type	IP 20	IP 20	IP 20
Features	<ul style="list-style-type: none"> <li>• Electromechanical time counter, fixed timing at the factory.</li> <li>• Coins or tokens operated.</li> <li>• Possibility of timing from 1 minute up to 120 minutes.</li> <li>• With or without pre-warning of time ending</li> </ul>	<ul style="list-style-type: none"> <li>• Electronic time counter.</li> <li>• Coins or tokens operated.</li> <li>• 1 digit display which counts up to 9 tokens or coins.</li> <li>• Pre warning of time ending by means of display flashing 1 minute before it finishes.</li> </ul>	<ul style="list-style-type: none"> <li>• Electronic time counter.</li> <li>• Coins or tokens operated.</li> <li>• Independent lock, one for the Electronic and other for the coin box.</li> <li>• Pre warning by means of relay (<b>short</b>: 30 seconds before it finishes for 10 seconds; <b>large</b>: 4 minutes before it finishes for 10 seconds).</li> <li>• It stores up to 99 tokens or coins in memory.</li> </ul>

To install in wet environment such as camp grounds, changing rooms, etc. a 24V transformer is necessary (on demand in separated box).

### Connection diagram

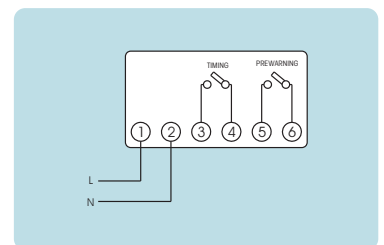
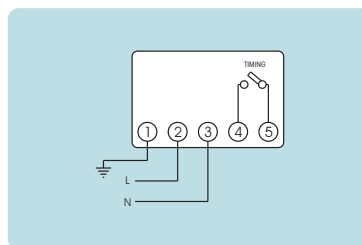
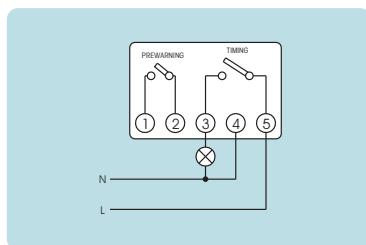

### Dimensions

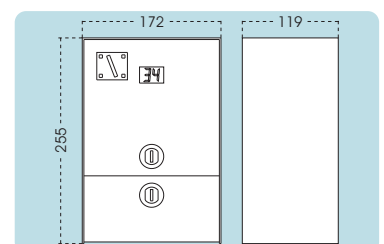
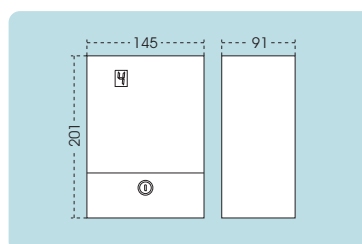
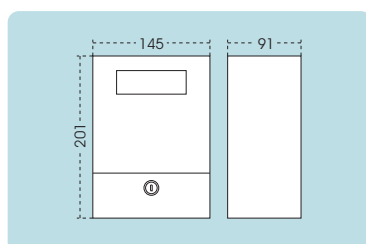



# INDUSTRIAL TIME SWITCHES

## MODUL



## SINCRO 341/ 351 SINCRO 346 / 356



### Description

Timer switch for industrial applications such as machinery, heating or air conditioning machines, etc. Personalized models are available with different mounting possibilities.

Designed for integration with any kind of equipment. Daily, weekly and countdown versions with different configuration, mounting and connexion possibilities. Different colours available on request.

### Features

<b>Power supply</b>	120 Va.c. or 230 Va.c.	110 Va.c. or 230 Va.c.
<b>Frequency</b>	MODUL D, MODUL S: 50 or 60 Hz. MODUL QRD, MODUL QRS: 50/60 Hz	50 or 60 Hz.
<b>Switching capacity</b>	16(4) A / 250 Va.c.	16(4) A / 250 Va.c. 21(8) A / 250 Va.c.
<b>Own consumption</b>	1.8 VA	1.8 VA
<b>Battery back-up</b>	MODUL D, MODUL S: No reserve MODUL QRD, MODUL QRS: 100 hours	Without reserve
<b>Dial / minimum switching time</b>	MODUL D, MODUL QRD: Daily/15 min. MODUL S, MODUL QRS: Weekly/2 hours.	SINCRO 341 T15-346 T15: Daily/15 min. SINCRO 341 T30-346 T30: Daily/30 min. SINCRO 351-356: Weekly/105 min. SINCRO 341 K60-346 K60: Countdown/60 min. SINCRO 341 K150-346 K150: Countdown/150 min. SINCRO 341 K900-346 K900: Countdown/900 min.
<b>Manual control</b>	With (ON-Automatic-OFF) or without manual control	SINCRO 341/351: ON-OFF-Automatic. SINCRO 346/356: With (ON-OFF-Automatic) or without manual control
<b>Clock hands</b>	With or without	With
<b>Operating temperature</b>	D and S: from 0°C to +55°C QRD and QRS: from -10°C to +45°C	from 0°C to +85°C

### Connection diagram

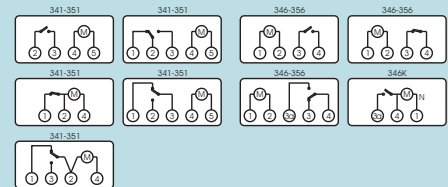
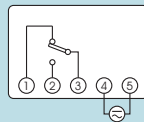

### Dimensions

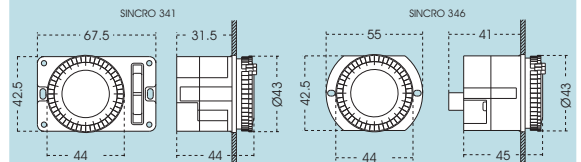
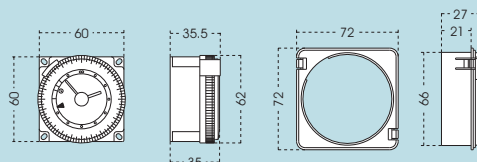

# STAIRCASE TIME SWITCHES

**T-22**



**T-16G**



**T-PR**



**T-11 20A**



## Description

Timing of staircase light circuits in seconds or minutes, in offices and home buildings, community courtyards, etc. DIN rail and surface mounting.

## Features

<b>Resettable</b>	Yes	Yes	Yes	Yes
<b>Manual switch</b>	ON – Automatic	ON - Automatic	ON – Automatic - pre warning	ON - Off – Automatic
<b>Rated voltage</b>	120 or 230 Va.c.	120 or 230 Va.c.	230 Va.c.	120 or 230 Va.c.
<b>Switching capacity</b>	16 (4) A / 230 Va.c.	10 A / 230 Va.c.	16 A / 230 Va.c.	20 A / 230 Va.c.
<b>Luminous push buttons</b>	50 mA max.	50 mA max.	150 mA max.	50 mA max.
<b>Maxim. recommended load</b>				
Incandescent	3000 W	2000 W	3000 W	4000 W
Non-compensated fluorescent	500 W	300 W	500 W	1100 W
Compensated fluorescent	500 W	300 W	500 W 60 µF	1100 W 139 µF
Low voltage halogen	2250 VA	1200 VA	650 VA	2000 VA
Halogen (230 Va.c.)	3000 W	2000 W	2500 W	4000 W
Low consumption lamps	500 W	350 W	10x23 W	800 W
<b>Temporization</b>	45 s to 7 min.	3 min. to 30 min.	45 s to 12 min.	1 to 3 min.
<b>Operating temperature</b>	-10°C to +50°C	-10°C to +50°C	-10°C to +45°C	-10°C to +60°C
<b>Installation</b>	3 or 4 wires	3 or 4 wires	3 or 4 wires	3 wires
<b>Mounting</b>	DIN Rail	DIN Rail	DIN Rail	Surface
<b>Protection type</b>	IP 20	IP 20	IP 20	IP 20

## Connection diagram

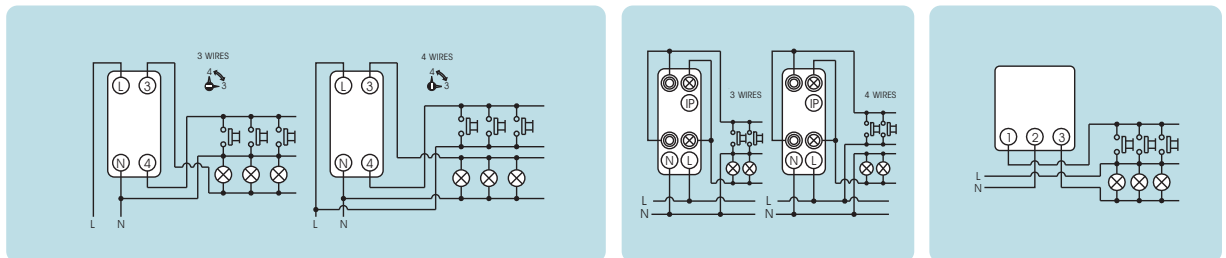

## Dimensions

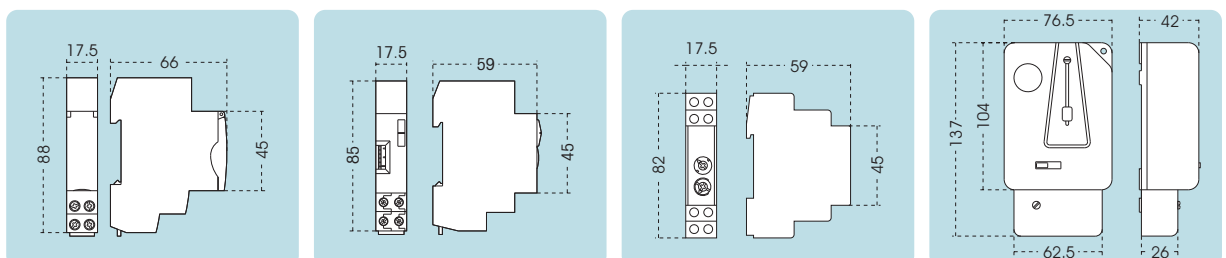

# STAIRCASE TIME SWITCHES

## PULSALUZ



## PULSAMAT



## ORBITEMP



## MICROTEMP



### Description

Timing of staircase light circuits in seconds or minutes, in offices and home buildings, community courtyard, etc. Mechanism or junction box mounting.

### Features

<b>Resettable</b>	Yes	Yes	Yes	Yes
<b>Rated voltage</b>	120 or 230 Va.c. / 45-60 Hz	230 Va.c. / 50 Hz	120 or 230 Va.c. / 45-60 Hz	230 Va.c. / 50-60 Hz
<b>Manual switch</b>	1, 5 A / 230 Va.c.	3 A / 230 Va.c. ~ cos φ = 1	1, 5 A / 230 Va.c.	-
<b>Luminous push buttons</b>	6 mA / 230 V; 3mA / 120 V	6 mA max.	6 mA / 230 V; 3mA / 120 V	Unlimited
<b>Maxim. recommended load</b>				
Incandescent 230 V	25 W - 300 W (Incandescent only)	500 W	25 W - 300 W (Incandescent only)	25 W - 400 W
Incandescent 120 V	25 W - 150 W (Incandescent only)		25 W - 150 W (Incandescent only)	
Non-compensated fluorescent		120 W		
Compensated fluorescent		120 W / 12 μF		
Low voltage halogen		400 VA		50 VA - 250 VA
Halogen (230 Va.c.)		500 W		25 W - 400 W
Low consumption lamps		100 W		
<b>Temporization</b>	30 s to 4 min.	30 s to 10 min.	30 s to 4 min.	30 s to 10 min.
<b>Operating temperature</b>	-10°C to +50°C	-10°C to +50°C	-10°C to +50°C	-10°C to +50°C
<b>Installation</b>	2 wires	3 wires	2 wires	2 wires
<b>Mounting</b>	Into mechanism box	Into mechanism box	Into mechanism box	Behind a push-button or inside junction box.
<b>Protection type</b>	IP 20	IP 20	IP 20	IP 20

### Connection diagram

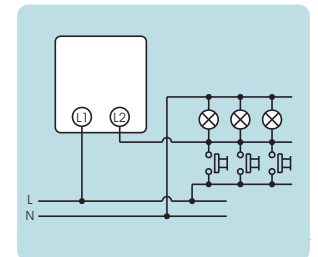
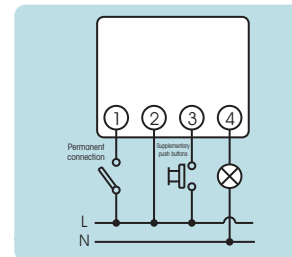
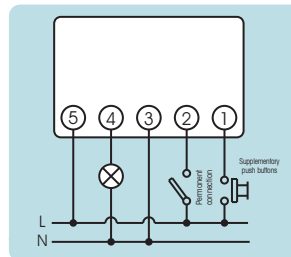
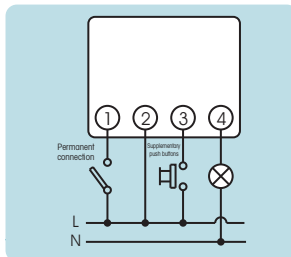

### Dimensions

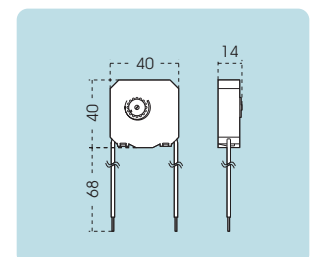
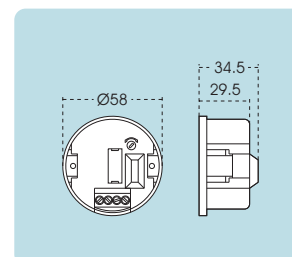
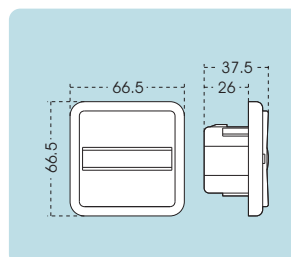
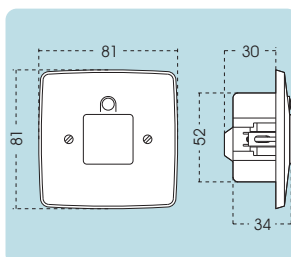



























# MOTION SENSOR SWITCHES













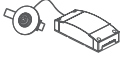



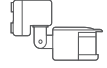





## MOTION SENSOR SWITCHES CLASSIFICATION

### WALL

									
		SENSOMAT	MOVIMAT	ISIMAT	ISIMAT +	MULTIMAT	PROXIMAT	ORBIMAT	ECOMAT
									
									
Wall	Surface	Until 140°	★★	★★	★★	★★	★★		★
		Until 180°	★★★★	★★		★★	★★	★★★★	★
		Until 200°		★★★★		★★★★	★★	★★	★
		Until 240°					★★★		★
		Until 270° (*)							★★★★
		Internal or external corner				★★★	★★★		★★★
	Into mechanism box						★★★		

(\*) In closed spaces (optimum in corridors, halls, etc. No suitable in garages, warehouses, etc.)

### CEILING

									
		DICROMAT MICRO	DICROMAT MINI / DICROMAT 2 MINI	DICROMAT / DICROMAT 2	DICROMAT + / DICROMAT 2+	CIRCUMAT	ECOMAT	MULTIMAT	MOVIMAT
									
									
Ceiling	Built-in	Halls	★★	★★★★	★	★			
		Ø6m Areas	★★★★		★★	★★			
		Long corridors, internal and external corners and areas bigger than Ø6m	★		★	★★★★			
		Surface					★★★		★★★★
	Hidden over ceiling						★★★		



Outdoor

Outdoor under cover

Indoor



Suitable for fluorescent



Not suitable for fluorescent



Fluorescent By means of contactor

★ Suitable

★★ Recommended

★★★ Highly recommended

# MOTION SENSOR SWITCHES

## SENSOMAT



## MOVIMAT



## ISIMAT / ISIMAT+



## MULTIMAT



### Description

Presence switches for the automatizing of light circuits in buildings, hotels, residences, offices, etc. Can be installed on the wall (flat, internal or external corner), on the ceiling (surface or built-in) or even hidden in the ceiling.

### Features

<b>Angle</b>	180°	200°	<b>ISIMAT:</b> 140°; <b>ISIMAT +:</b> 200°	200°
<b>Detection field</b>	<b>Forward:</b> 12 m to 20°C <b>Side:</b> 6 m to 20°C	0 to 12 m to 20°C	<b>Forward:</b> 12 m to 20°C <b>Side:</b> 8 m to 20°C	<b>Forward:</b> 12 m to 20°C <b>Side:</b> 8 m to 20°C
<b>Rated voltage</b>	230 Va.c. / 50 Hz	230 Va.c. / 50-60 Hz	230 Va.c. / 50 Hz	230 Va.c. / 50 Hz
<b>Switching capacity</b>	10 A / 230 Va.c. ~ cos φ = 1	5 A / 230 Va.c. ~ cos φ = 1	5 A / 230 Va.c. ~ cos φ = 1	10 A / 230 Va.c. ~ cos φ = 1
<b>Maxim. recommended load</b>				
Incandescent	1000 W	1000 W	1000 W	2000 W
Non-compensated fluorescent	500 W	180 W	500 W	1000 W
Compensated fluorescent	250 W	By means of contactor	250 W	500 W
Low voltage halogen	500 VA	By means of contactor	500 VA	1000 VA
Halogen (230 Va.c.)	1000 W	500 W	1000 W	2000 W
Low consumption lamps	200 W	By means of contactor	200 W	400 W
<b>Adjustable parameters</b>	Time and light sensitivity	Time, light sensitivity and field of detection	Time and light sensitivity	Time and light sensitivity
<b>Temporization</b>	10 s to 10 min. approx.	6 s to 10 min.	3 s to 30 min. / ON permanent 6 hours	3 s to 30 min. / ON permanent 6 hours
<b>Light sensitivity</b>	5 - 300 - ∞ lux.	5 - 300 - ∞ lux.	5 - 30 - 2000 lux.	5 - 30 - 2000 lux.
<b>Operating temperature</b>	-10°C to +50°C	-20°C to +40°C	-20°C to +40°C	-20°C to +40°C
<b>Own consumption</b>	8, 5 VA (1 W approx.)	11 VA	8, 5 VA (1, 5 W approx.)	8, 5 VA (1, 5 W approx.)
<b>Installation</b>	Surface (on wall)	Surface (on wall or ceiling)	Surface (on wall)	Surface (on wall or roof with connection base)
<b>Protection type</b>	IP 44	IP 44	IP 44	IP 55

### Connection diagram

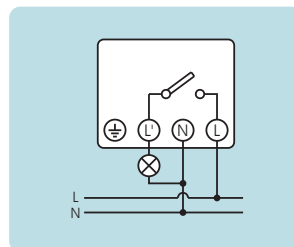
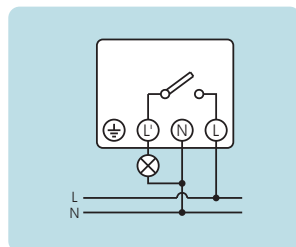
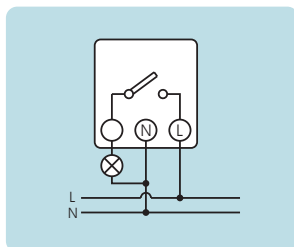
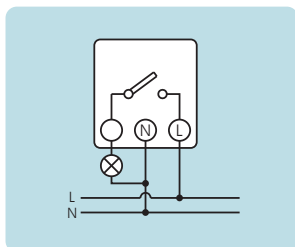

### Dimensions

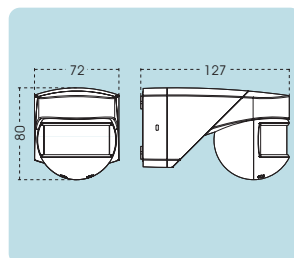
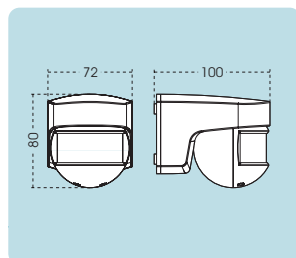
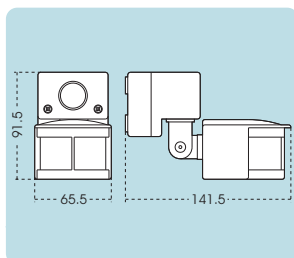
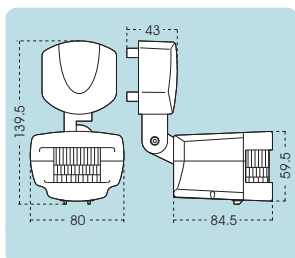

# MOTION SENSOR SWITCHES

## ORBIMAT



## PROXIMAT



## ECOMAT



## CIRCUMAT



### Description

Presence switches for the automatizing of light circuits in buildings, hotels, residences, offices, etc. Can be installed on the wall (flat, internal or external corner), built in on the mechanism box and on the ceiling (surface or hidden in the false plaster ceiling).

### Features

Angle	195°	240°	270°	360°
Detection field	0 to 8m to 20°C	12 m to 20°C	1, 7 m height: From 0, 5 to 6 m forward and 3 m side	Up to 7 m diameter to 2, 5 m height to 20°C
Rated voltage	230 Va.c. / 50-60 Hz	230 Va.c. / 50 Hz	230 Va.c. / 50 Hz	230 Va.c. / 50-60 Hz
Switching capacity	2 A / 230 Va.c. ~ cos φ = 1	10 A / 230 Va.c. ~ cos φ = 1	6 A / 230 Va.c. ~ cos φ = 1	10 A / 230 Va.c. ~ cos φ = 1
Maxim. recommended load				
Incandescent	40 - 400 W	2000 W	1000 W	1000 W
Non-compensated fluorescent	40 - 150 W	1000 W	500 W	500 W
Compensated fluorescent	Not suitable	500 W	500 W	250 W
Low voltage halogen	40 - 150 VA	1000 VA	500 VA	500 VA
Halogen (230 Va.c.)	40 - 150 W	2000 W	1000 W	1000 W
Low consumption lamps	Not suitable	400 W	200 W	200 W
Adjustable parameters	Time, light sensitivity and field of detection	Time, light sensitivity and field of detection	Time, light sensitivity and field of detection	Time and light sensitivity
Temporization	From 6 s to 12 min. approx.	From 10 s to 10 min. approx.	From 3 s to 30 min.	From 3 s to 10 min. approx.
Light sensitivity	5 - 300 - ∞ lux.	5 - 30 - 2000 lux.	0, 5 - 2000 lux.	3 - 300 - ∞ lux.
Operating temperature	-15°C to +45°C	-10°C to +40°C	0°C to +50°C	-20°C to +40°C
Own consumption	11 VA (1 W approx.)	8, 5 VA (1, 1 W)	0, 96 W	Less than 2 W
Installation	Mechanism box	Surface (on wall: flat, internal or external corner)	Surface (on wall: flat, internal or external corner). Hidden over false ceiling	On ceiling up to 5 m. maximum height
Protection type	IP 20	IP 45	IP 20	IP 20
Connection diagram				
Dimensions				

# MOTION SENSOR SWITCHES

## DICROMAT MICRO



## DICROMAT MINI DICROMAT 2 MINI



## DICROMAT + DICROMAT 2+ DICROMAT SENSOR +



### Description

Presence switches for the automatizing of light circuits in buildings, hotels, residences, offices, etc. Mounted built in on the ceiling.

### Features

Angle	360°	360°	360°
Detection field	Up to 4 m diameter to 2, 5 m height	Up to 7 m diameter to 2, 5 m height	Up to 7 m diameter to 2, 5 m height
Rated voltage	230 Va.c. / 50 Hz	230 Va.c. / 50 Hz	230 Va.c. / 50 Hz
Switching capacity	10 A / 230 Va.c. ~ cos φ = 1	T1: 10 A / 230 Va.c. ~ cos φ = 1 T2: 5 A / 250 Va.c. ~ cos φ = 1	Dicromat +: 10 A / 230 Va.c. ~ cos φ = 1 Dicromat 2+: 2 x 10 A / 230 Va.c. ~ cos φ = 1
Maximum recommended load	Incandescent 2000 W Non-compensated fluorescent 400 W Compensated fluorescent By means of contactor Low voltage halogen 300 VA Halogen (230 Va.c.) 1000 W Low consumption lamps By means of contactor	T1: 2000 W 400 W By means of contactor 300 VA 1000 W By means of contactor	2200 W 800 W 400 W 1000 VA 2200 W 400 W
Adjustable parameters	Time and light sensitivity	Time (T1 and T2) and light sensitivity	Time (T1 and T2), light sensitivity and field of detection.
Temporization	T <sub>1</sub> : de 6 s a 12 min.	<b>DICROMAT MINI:</b> T <sub>1</sub> : from 6 s to 12 min. <b>DICROMAT 2 MINI:</b> T <sub>1</sub> : from 6 s to 12 min. T <sub>2</sub> : from 10 s to 30 min.	<b>DICROMAT +:</b> T <sub>1</sub> : from 6 s to 12 min. <b>DICROMAT 2+:</b> T <sub>1</sub> : from 6 s to 12 min. T <sub>2</sub> : from 10 s to 20 min.
Light sensitivity	Adjustable from 5 Lux. Up to ∞	Adjustable from 5 Lux. to ∞	2 - 2000 lux.
Operating temperature	-10°C to +45°C	-10°C to +45°C	-10°C to +45°C
Own consumption	8 VA Capacitive (1 W)	<b>DICROMAT MINI:</b> 8 VA Capacitive (1 W approx.) <b>DICROMAT 2 MINI:</b> 10 VA Capacitive (1, 5 W approx.)	<b>DICROMAT +:</b> 7 VA Capacitive (1.1 W approx.) <b>DICROMAT 2+:</b> 4, 2 VA Inductive (3.1 W approx.)
Protection type	IP 20	IP 20	IP 20

### Connection diagram

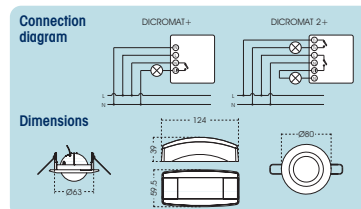
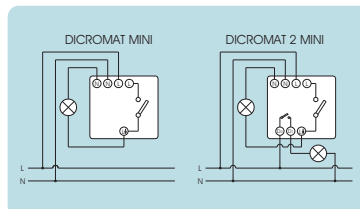
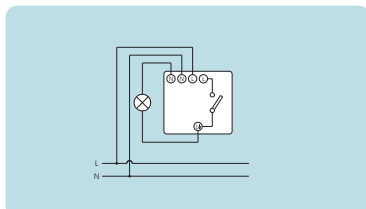

### Dimensions

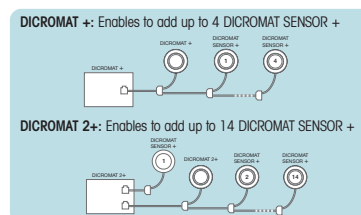
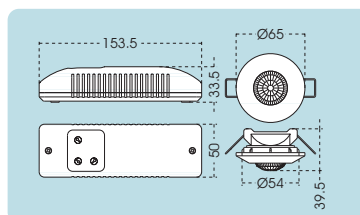
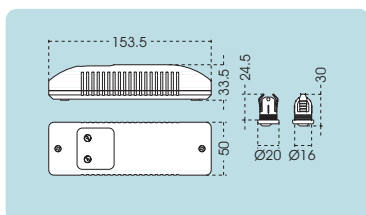

# DOOR BELLS / HOUR COUNTERS

## ORBISON



## ORBISON DUO



## CONTA EMPOTRABILE



## CONTA MODULAR



### Description

Door bell with two musical notes, two versions: for one or two access to housing.

Hour counters for machinery and maintenance works, mounted in DIN rail or panel.

### Features

Rated voltage	230 Va.c. / 50-60 Hz 6, 12, 24 or 48 Va.c. /d.c.	230 Va.c. / 50-60 Hz 6, 12, 24 or 48 Va.c. /d.c.	24, 48, 110, 230 or 400 Va.c./50Hz from 12 to 80 Vd.c.	230 Va.c. / 50 Hz
Own consumption	-	-	3W max.	4W max.
Counting range	-	-	99999, 99 hours	99999, 99 hours
Accuracy	-	-	0, 01 hour	0, 01 hour
Musical notes	2	2 + buzzer	-	-
Installation	Surface	Surface	Panel mounting	DIN Rail
Protection type	-	-	IP 65	IP 65
Operating temperature	-	-	-20°C to +70°C	-10°C to +70°C

### Connection diagram

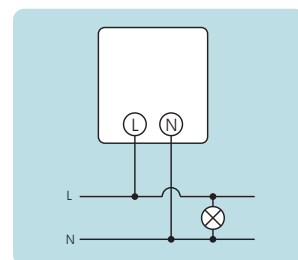
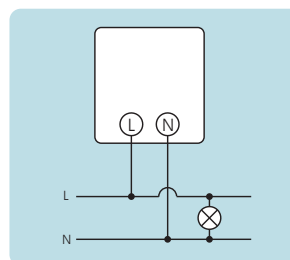
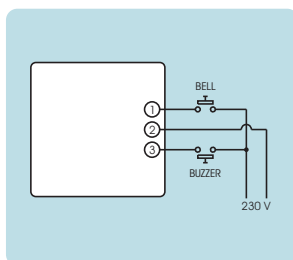
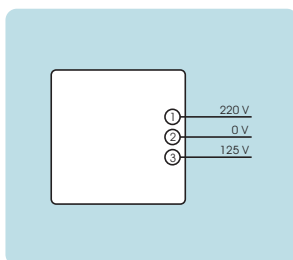

### Dimensions

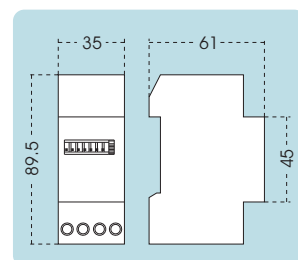
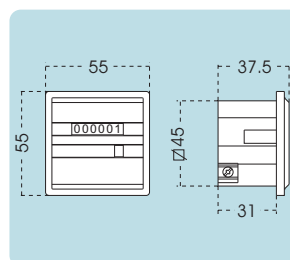
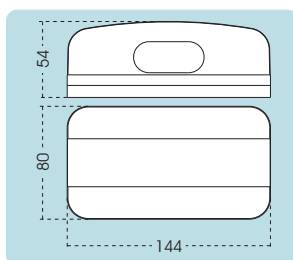
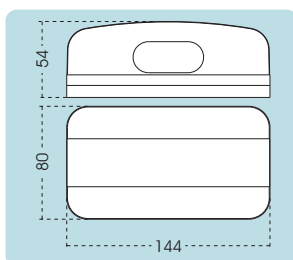



# LEVEL CONTROL RELAY / PHASE DISCONNECTOR

**EBR-1**



**EBR-2**



**FR12-1**



## Description

They are designed for controlling the filling and emptying of water wells and tanks by means of probes

The mains disconnection switch disconnects the power supply once all series connected loads are turned off, thus preventing any electromagnetic interference fields from occurring.

## Features

Rated Voltage	230 Va.c.	230 Va.c. or 400 Va.c.	230 Va.c. Voltage control: 5 V-230 Vd.c. programmable
Frequency	50 - 60 Hz	50 - 60 Hz	-
Switching capacity	6(2) A 250 Va.c.	8 (2) A 230 Va.c. / 4 (1) A 400 Va.c.	16 A / 230 Va.c. $\sim \cos \varphi = 1$
Own consumption	3, 5 VA	4 VA	0, 8 W
Sensitivity	50 k $\Omega$ maximum	From 0 to 50 k $\Omega$	5 mA-200 mA
Operating temperature	-10°C to +45°C	-10°C to +45°C	-10°C to +45°C
Protection Class	II according to EN 60335	II according to EN 60335	II according to EN 60335
Protection type	IP 20	IP 20	IP 20
Installation	DIN rail	DIN rail	DIN rail
Accessories	Optional: 3 probe set	Optional: 6 probes set	<b>GLE 12-3:</b> Special load accessory

## Connection diagram

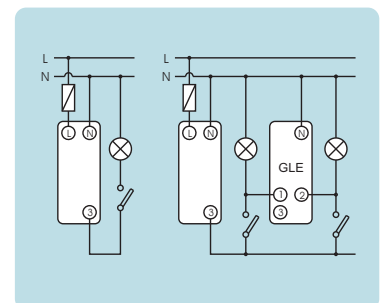
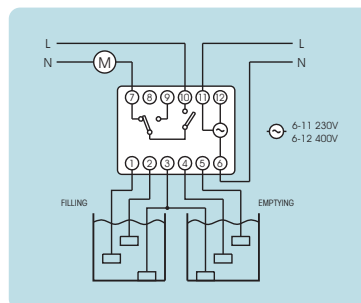
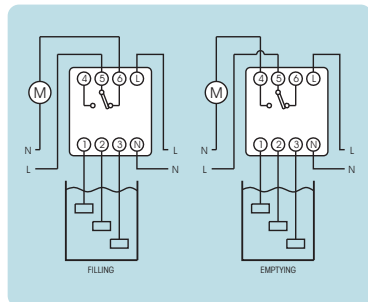

## Dimensions

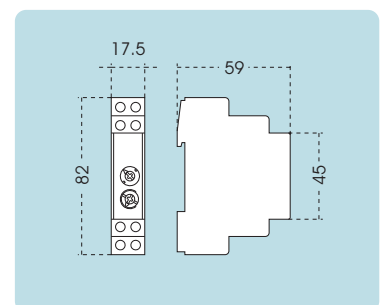
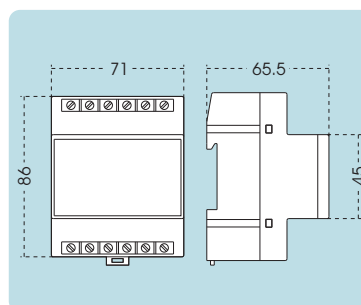
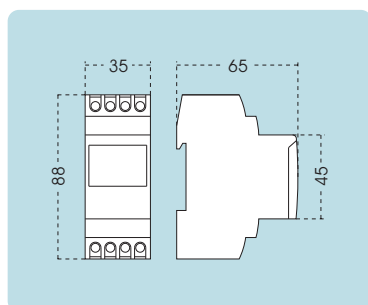

# MODULAR SINGLE PHASE ENERGY METERS

## CONTAX 2511 SO



## CONTAX 3221 SO/ CONTAX 3221 ZIGBEE



## CONTAX 6521 SO



### > Description

Active single phase energy meters for individual consumption controlling in camp grounds, resorts, stands, marinas, etc. With communication possibility, DIN rail mounting.

### > Features

Reference voltage $U_n$	230 Va.c.	230 Va.c.	230 Va.c.
Ib base current, (I maximum)	5 (25) A	5 (32) A	10 (65) A
Frequency	50-60 Hz	50-60 Hz	50-60 Hz
Rated voltage	195 to 253 V	195 to 253 V	195 to 253 V
Operating current	0, 02 to 25 A	0, 02 to 32 A	0, 04 to 65 A
Starting-up current with power factor = 1	15 mA typical	15 mA typical	40 mA typical
Own consumption	0, 5 VA approx.	7, 5 VA approx. (0, 8 W)	7, 5 VA approx. (0, 8 W)
Precision accuracy class	1	1	1
Numeric integrator	5 digits (kWh) + 1 decimal place (n x 0, 1 kWh)	5 digits (kWh) + 1 decimal place (n x 0, 1 kWh)	5 digits (kWh) + 1 decimal place (n x 0, 1 kWh)
Pulse transmission	SO Type	<b>CONTAX 3221 SO:</b> SO Type <b>CONTAX 3221 ZIGBEE:</b> Wireless by means of USB ZIGBEE accessory and software CONTAX ZIGBEE	SO Type
Recorded harmonics	Up to 7kHz	Up to 7kHz	Up to 7kHz
Operating temperature	-20 °C to +50 °C	-20 °C to +50 °C	-20 °C to +50 °C
Installation	DIN Rail	DIN Rail	DIN Rail

### Connection diagram

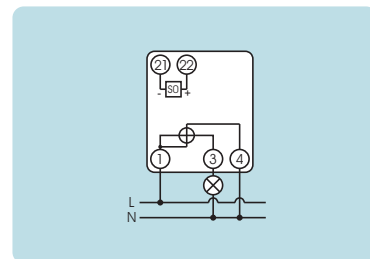
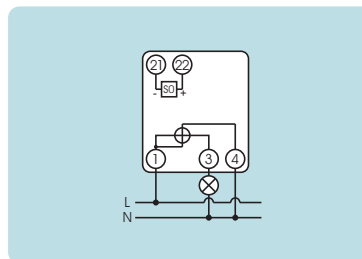
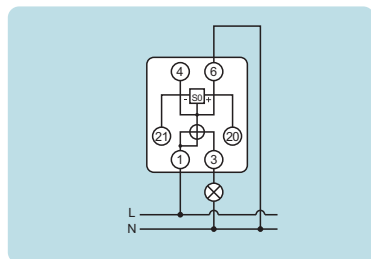

### Dimensions

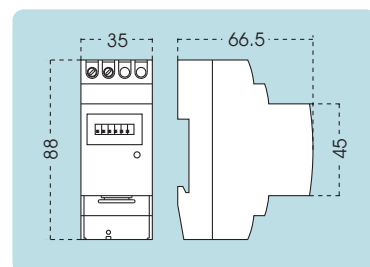
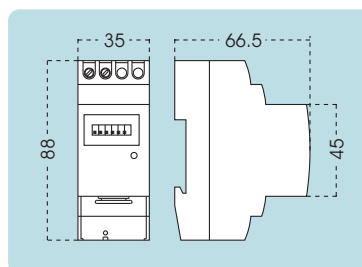
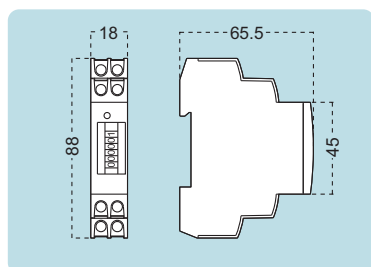

# MODULAR SINGLE PHASE ENERGY METERS

## CONTAX 0641 SO



## CONTAX D-2221



## CONTAX D-6331 SO



### Description

Active single phase energy meters for particular consumption controlling in camp grounds, resorts, stands, marinas, etc. With communication possibility, DIN rail mounting.

### Features

Rated voltage	230 Va.c.	230 Va.c.	230 Va.c.
Frequency	50-60 Hz	50-60 Hz	50-60 Hz
Ib base current, (I maximum)	5 (6) A	10 (22, 5) A	10 (63) A
Starting-up current with power factor = 1	15 mA	25 mA	40 mA
Own consumption	Voltage circuits < 2, 5 VA Current circuits < 2, 5 VA	4 VA	Voltage circuits < 2, 5 VA Current circuits < 2, 5 VA
Transformers ratio selection	5-10-25-50-75-100-125-150-200-250-300-400-500-600-800-1000/5 A	Direct connexion	Cable passage
Operating temperature	-10°C to +45°C	-10°C to +45°C	-10°C to +45°C
Relative humidity	95% maximum without condensation	10% to 90% without condensation	10 to 90% without condensation
Precision accuracy class	2	2	1
Numeric integrator	Mechanic 7 digits	<b>Partial meter with reset:</b> 5 digits <b>Total meter:</b> 7 digits	<b>Partial meter with reset:</b> 5 digits <b>Total meter:</b> 7 digits
Pulse transmission	SO type	-	SO type
Protection category	IP 20	IP 20 / IP51 in front	IP 20 / IP51 in front
Installation	DIN rail	DIN rail	DIN rail

### Connection diagram

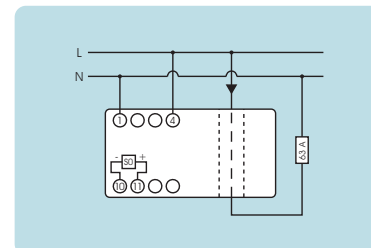
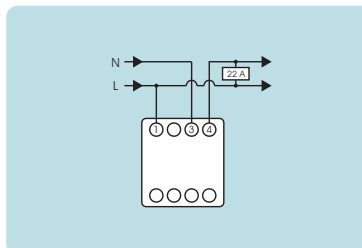
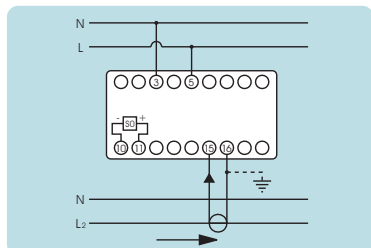

### Dimensions

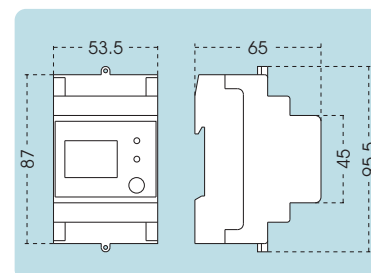
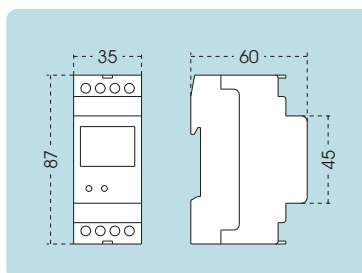
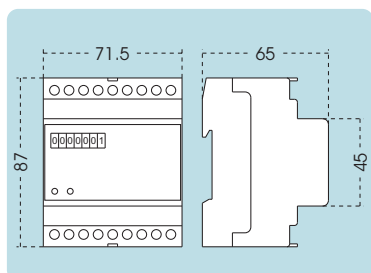

# MODULAR THREE PHASE ENERGY METERS

**CONTAX 0643 S0 /  
CONTAX 0643i S0**



**CONTAX 0643 AR S0**



**CONTAX D-9073 S0**



**PULSE COLLECTOR**

**CONTAX NET**



## Description

Active three phase energy meters for consumption controlling in machinery and installations. With communication possibility, DIN rail mounting.

## Features

<b>Rated voltage</b>	3x230 (400) Va.c.	3x230 (400) Va.c.	3x230 (400) Va.c.	The pulse collector enables to read pulses from any CONTAX meter with S0 communication (single and three phases). The pulses can be transmitted to a main computer by means of an RS323 connection Each CONTAX NET can read (by means of SOFTWARE CONTAX NET) up to 8 signals from the CONTAX. With an RS485 net work is possible to read up to 31 CONTAX without repeater up to 1000 m distance. Up to 247 CONTAX NET can be connected in groups of 30 with amplifiers
<b>Frequency</b>	50-60 Hz	50-60 Hz	50-60 Hz	
<b>Own consumption</b>	Voltage circuits < 2, 5 VA Current circuits < 2, 5 VA	< 2, 5 VA	< 2,5 VA	
<b>Ib base current, (I maximum)</b>	5 (6) A	10 (90) A	10 (90) A	
<b>Starting-up current with power factor = 1</b>	15 mA	40 mA	40 mA	
<b>Transformers ratio selection</b>				
<b>Operating temperature</b>	-10°C to +45°C	-10°C to +45 °C	-10°C a +45 °C	
<b>Relative humidity</b>	95% maximum without condensation	10% to 90% without condensation	10% to 90% without condensation	
<b>Precision accuracy class</b>	2	1	1	
<b>Numeric integrator</b>	Mechanic 7 digits	<b>Partial meter with reset:</b> 5 digits <b>Total meter:</b> 7 digits	<b>Partial meter with reset:</b> 5 digits <b>Total meter:</b> 7 digits	
<b>Pulse transmission</b>	S0 Type	S0 type	S0 type	
<b>Protection type</b>	IP 20	IP 20 / IP 51 in front	IP 20 / IP 51 in front	
<b>Installation</b>	DIN Rail	DIN Rail	DIN Rail	

## Connection diagram

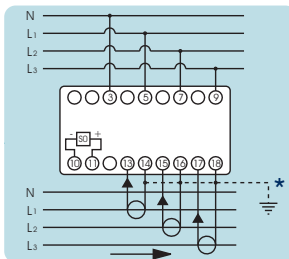

\* Model 0643i/S0

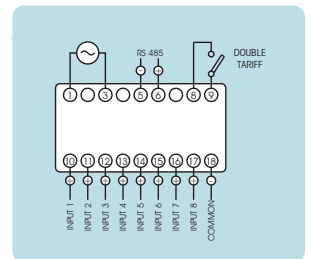
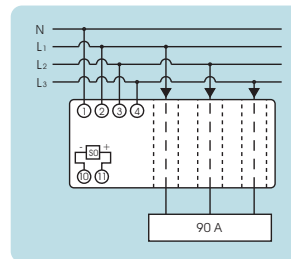
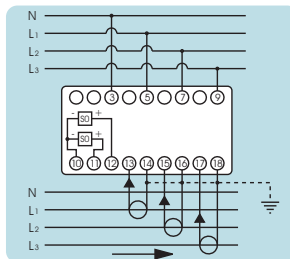

## Dimensions

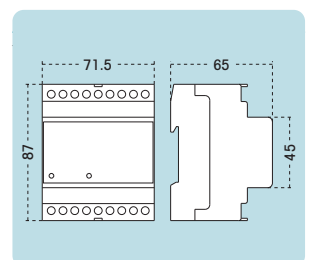
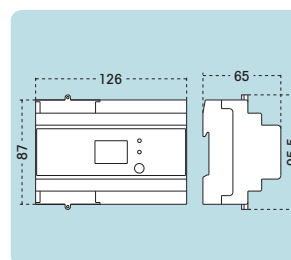
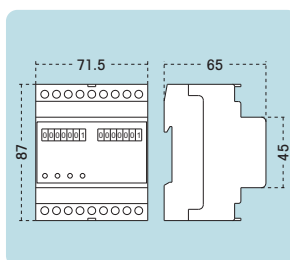
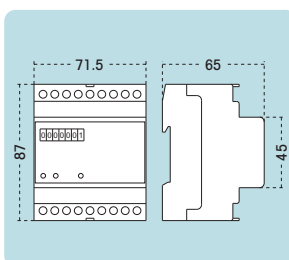

# TARIFF ENERGY METER-SINGLE PHASE

## MFR



### Features

Reference voltage $U_n$	230 Va.c.
$I_b$ base current, (I maximum)	10 (60) A 15 (60) A
Frequency	50 Hz
Operating voltage	from 0, 8 to 1, 1 $U_n$
Starting-up current	0, 5% $I_b$
Own consumption	Voltage circuits: 0, 9 W; 4 VA Current circuits: 0, 4 VA
Precision class	2
Protection class	II according to EN60335
Protection type	IP 51
Installation	Fastening triangle

MFR is a single phase electromechanical energy meters, active energy class 2, 2 wires direct connection.

There are two models, it depends on the maximum and base current: 10(60) A and 15(60) A.

The internal mechanism is designed to keep running in positive direction, even in case of connection error.

Mechanical display 6 digits (5+1 decimal).

### Connection diagram

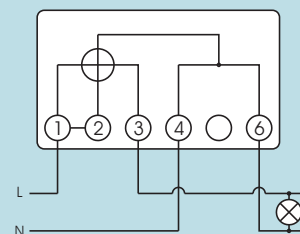

### Dimensions

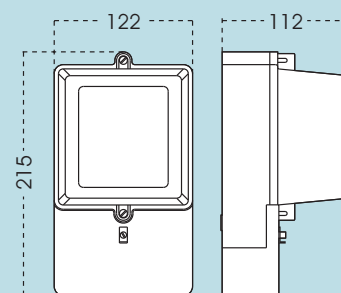

## MER



### Features

Reference voltage $U_n$	230 Va.c.
$I_b$ base current, (I maximum)	10 (60) A 15 (60) A
Frequency	50 Hz
Operating voltage	From 0, 5 to 1, 5 $U_n$
Starting-up current	0, 2% $I_b$
Own consumption	Voltage circuits: 0, 7 W rated load Current circuits: 0, 3 W rated load
Precision class	2
Protection class	II according to EN60335
Protection type	IP 51
Installation	Fastening triangle
Periods	Up to two
Battery life	10 years

MER is an active energy meter; it is static single phase meter which means that it can substitute the import and export meter and the tariff time switch.

Period closing by means of button, 6 digit display

### Connection diagram

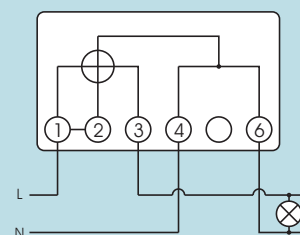

### Dimensions

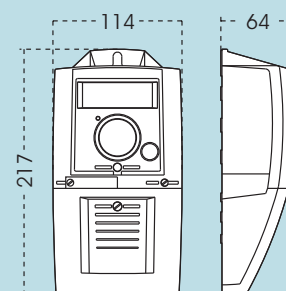



## DOMOTAX



DOMOTAX is a multifunction, static, single phase energy meter for active (Class 1) or active/reactive energy, two wires direct connection.

DOMOTAX can substitute the import and export meter and the tariff time switch. Therefore, it can manage up to four periods with maxi meter.

There is also, a bidirectional model to measure the import and export energy in solar applications.

From a basic model it is possible to add communication by RS232, RS485, SO pulse or pulse emissions (without voltage).

The RS485 is suitable for remote installations reading. It can be made with maximum delay / relay on demand.

Therefore, it is a perfect energy meter in double tariff and solar applications.

### > Features

Reference voltage $U_n$	230 V a.c.
Ib base current, (I maximum)	10 (60) A
Frequency	50 Hz
Operating voltage	from 0, 8 to 1, 1 $U_n$
Starting-up current	40 mA (0.4% Ib)
Own consumption	Voltage circuits: < 2VA Current circuits: < 1VA
Precision class	1
Protection class	II according to EN60335
Protection type	IP 51
Installation	Fastening triangle

### > Connection diagram

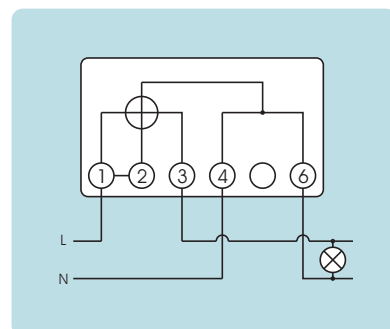

### > Dimensions

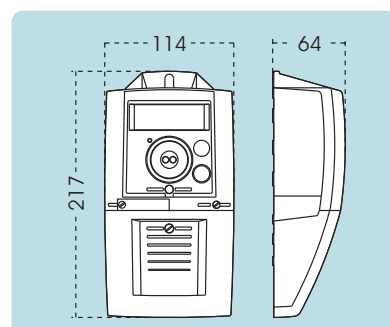

# MULTIFUNCTION ENERGY METER-THREE PHASES

## ORBITAX T3



The ORBITAX T3 is a combined meter-recorder in a single piece of electronic equipment having electric power measurement and main analyser functions that comply with all EEC regulations and with the imposed specifications for applying various access tariff contracts, electronic signature and two load curves.

It uses the IEC 870-5-102 communications protocol adapted by the system operator.

The ORBITAX T3 performs the power measurement in four quadrants and can operate in unidirectional or

bidirectional mode. It discriminates between CAPACITIVE or INDUCTIVE when performing reactive energy measurements.

The meter measurement system is based on the very latest cutting-edge developments in power meters/digital watt meters. By digitising both voltage and current waveforms in three phases and employing digital calculations, r.m.s. values for voltage, current, active power, reactive power and power factor are obtained in addition to other electrical parameters.

The ORBITAX T3 also incorporates pulse transmitters and calibration LED. Communication with the ORBITAX T3 is achieved using an infrared port in accordance with EN 62056-21 (third edition EN 60107) which works with most optical collectors.

It also includes an RS-232 port, which can be replaced by RS-485 on order. These communications ports make use of RJ11 quick connections and permit modem communications in accordance with IEC 870-5-102.

Using a powerful software application, the ORBITAX T3 allows the display of real-time current, voltage, power, energy, power factor and frequency data on the computer screen, together with recording any excesses or defects in current, voltage, energy or power.

These characteristics make the ORBITAX an ideal meter for industrial installations and photovoltaic solar applications connected to the grid.

### Technical Specifications

- Class 1 active energy and class 2 reactive energy
- Class 0.5s active energy and class 1 reactive energy
- Completely electronic system
- Direct current measurement 10 (80) A or via a current transformer x/5 A
- Active and reactive verification Led's
- Configurable auxiliary outputs:
  - 4 pulse repeaters (active, active direction, reactive, reactive direction) in accordance with the SØ standard
  - 1 tariff relay or 1 maxi meter relay and 4 programmable digital outputs
- Alphanumerical LCD display
- 8-digit power/maximum display  
Programmable from 1 to 3 decimals
- Maximum value recording for the last 12 periods, with date/time and applied tariff indications
- Recording of the last 10 power failures (exceeding 0.5 seconds)
- Automatic or manual period closing (closed by button in the equipment) or in remote mode
- Closing date/time indication
- Optical communication port in accordance with EN 62056-2 (third edition of EN 60107)
- Factory-selectable optic-isolated communications port between RS232 and RS485
- Relay analyser incorporated
- It complies with IEC 870-5-102, adapted by the system operator
- 3 simultaneous contracts
- 3 and 6 period access tariff

### Models chart

Model	Accuracy	Features
ORBITAX r4hCcl05T3	0, 5 s Active class / 1 Reactive class	V > 1000 V; 450 kW < Pc < 10 MW; x/110 V; x/5 A
ORBITAX r4hCcl10T3	Active class / 2 Reactive class	V > 1000 V; 50 kW < Pc < 450 kW; x/110 V; x/5 A
ORBITAX r4hAc110T3	1 Active class / 2 Reactive class	V > 1000 V; 50 kW < Pc < 450 kW; x/5 A
ORBITAX r4hAc110T3	1 Active class / 2 Reactive class	V < 1000 V; 15 kW < Pc < 50 kW; x/5 A
ORBITAX d4hAc110T3	1 Active class / 2 Reactive class	V < 1000 V; 15 kW < Pc < 50 kW; Direct measurement 10(80) A
ORBITAX d4hAc110T3	1 Active class / 2 Reactive class	V < 1000 V; Pc < 15 kW; Direct measurement 10(80) A

### Dimensions

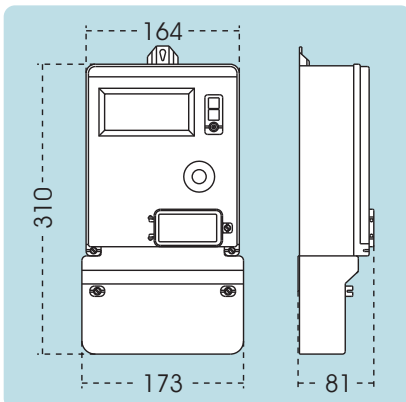

### Connection diagram

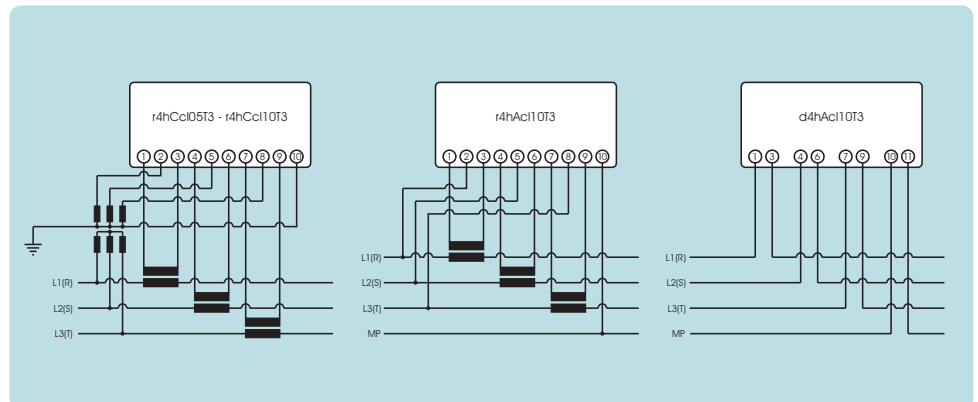

## ➤ MER - DOMOTAX – ORBITAX Accessories

### Optical reader

This provides the option to easily connect a portable reader unit to the measuring equipment. The optic-coupling can be quickly, easily and safely carried out for the user using a computer USB port and connecting the optical reader to the meter optical port.



### RS232 modem

This allows remote reading and importing of data from a meter using an RS-232 port and a GSM modem.

The assembly comprises: PC connection cable, antenna, metering connection cable, modem and power supply



### RS485 modem

This allows remote reading and importing of data from a meter using an RS-485 port and a GSM modem.

The assembly comprises: PC connection cable, antenna, modem connection cable, modem, RS232-RS485 converter and power supply.



### RS232 to RS485 adapter

This permits the conversion of an RS232 serial port into RS485 for reading several meters simultaneously. It includes a PC or modem RS-232 connection cable RS232-RS485 converter and power supply cable



### RS232/RS485 adapter to Ethernet

This is an assembly for reading a meter with RS-232 output or a meter network with RS-485 output over an Ethernet 10/100 Base TX network. It can be installed on a DIN rail or surface. Industrial grade. It works over a LAN and the Internet (TCP/IP).



### Read software



**ITACA T3:** automatic read software for ORBITAX T3.

**AGNI:** programmed read software for ORBITAX T3.

**DOMOTAX:** read software for DOMOTAX.

## ENERGEST 6051

### ➤ Description

ENERGEST 6051 is a load management solution. Two relays control load activation and deactivation in function of general consumption and the maximum power set point established by the user. It is very useful for heating control divided into three sections, to prevent exceeding the contracted maximum power and guaranteeing 100% accumulator load. It also permits the display of current, voltage, active power, reactive power,  $\cos \varphi$ , active energy and frequency.

### ➤ Features

<b>Rated voltage</b>	230 Va.c. / 50-60 Hz
<b>Ib base current, (I maximum)</b>	60 A
<b>Current measure</b>	By means of transformer
<b>Switching capacity</b>	2 x 2 A 250 Va.c.
<b>Relay functions</b>	NO/NC configuration Current reference value Hysteresis value Load activation delay Sample period to connect the load
<b>Accuracy</b>	Voltage 0, 5% Current 1% Power 2% Frequency $\pm 0, 1$ Hz Active energy class 2
<b>Display</b>	Back light LCD display
<b>Protection type</b>	IP 20 / IP 51 in front
<b>Installation</b>	DIN rail (4 modules)

### ➤ Dimensions

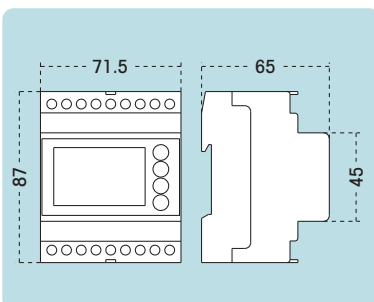

### ➤ Connection diagram

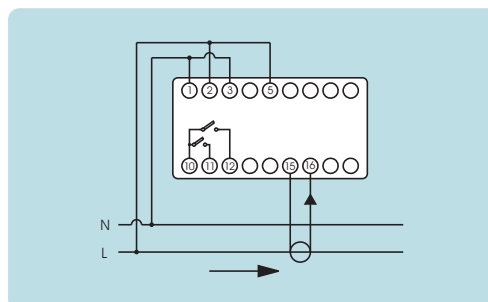

# ANALOG THERMOSTAT

## CLIMA ML

## CLIMA MLI

## CLIMA MLW

## CLIMA FANCOIL



### Description

ANALOG thermostats for air-conditioning and heating systems. Functioning by gas membrane, which guarantees a long accuracy life. Power supply is not necessary.

### Features

Rated voltage	Not necessary	Not necessary	Not necessary	Not necessary
Switching capacity	16 (2,5) A / 250 V	10 (1,5) A / 250 V	10 (1,5) A / 250 V	10 (1,5) A / 250 V
Manual control	-	ON/OFF + Neon indicator	Heating/air conditioning	Heating/Off/Air conditioning Speed 1 / Speed 2
Temperature range	5 °C to 30 °C	5 °C to 30° C	5 °C to 30 °C	5 °C to 30 °C
Functioning temperature	0 °C to 50 °C	0 °C to 50 °C	0 °C to 50 °C	0 °C to 50 °C
Protection class	II according to EN 60335	II according to EN 60335	II according to EN 60335	II according to EN60335
Protection type	IP 20	IP 20	IP 20	IP 20
Installation	Surface	Surface	Surface	Surface
Features	Room thermostat with small and compact design, high accuracy. Changeover contact.	Room thermostat with small and compact design, high accuracy. Changeover contact with on/off manual switch.	Room thermostat with a changeover contact and heating/air conditioning manual switch with on/off manual control. Therefore it is not necessary to manipulate the temperature selector to change between air conditioning and heating.	Room thermostat for Fancoil systems with 2 speeds selected by manual switch. Valid for heating and air conditioning systems.

### Connection diagram

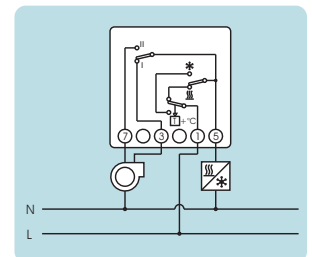
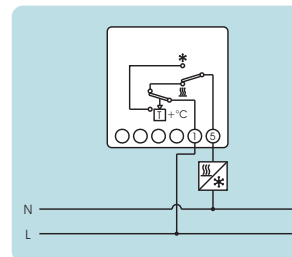
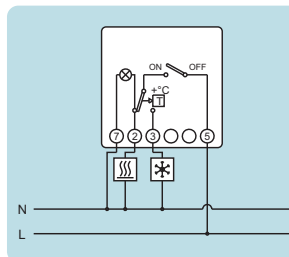
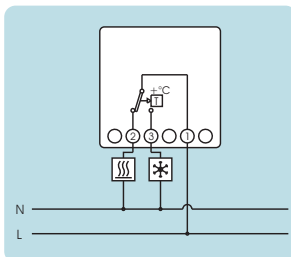

### Dimensions

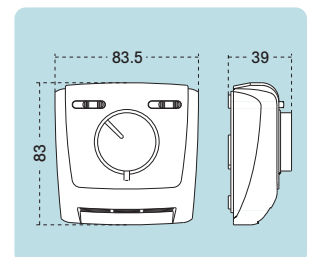
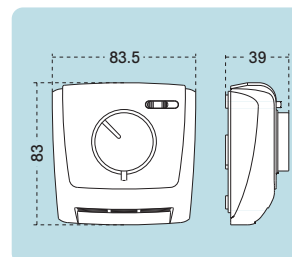
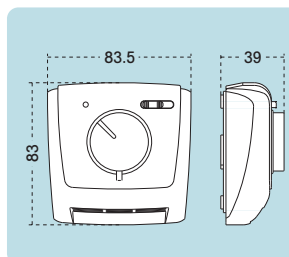
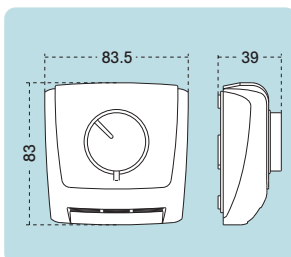

# ELECTRONIC THERMOSTATS

## LIV-A / LIV-DN-B



## NEO ML



## KLIO



### Description

KLIO enables telephone control (X.CODE WAVE or X.CODE GSM) and wireless connection with the air conditioning or heating machine by means of TX ATHENA and RX1 8A.

### Features

Rated voltage	LIV-A: 230 Va.c. - 50/60 Hz LIV-DN-B: 2 alkaline batteries 1, 5 V AAA	2 alkaline batteries 1, 5 V AAA (LR03)	2 alkaline batteries 1, 5 V AAA (LR03)
Switching capacity	8(5) A / 250 Va.c.	7(3) A / 250 Va.c.	8 A / 250 Va.c.
Battery life	1 year (LIV-DN-B)	1 year approximately	1 year approximately
Temperature measurement accuracy	-	± 0, 5 °C	± 0, 5 °C
Night temperature	D/N: -3 °C Day Temp.	-	Adjustable from 2 °C to 35 °C
Anti ice temperature	-	-	Adjustable from 0 °C to 15 °C
Temperature resolution	-	0, 1 °C	0, 1° C
Temperature regulation	5 °C to 35 °C approx.	5 °C to 35 °C	2 °C to 35 °C approx.
Operating temperature	0 °C to +50 °C	-10 °C to +45 °C	0 °C to +50 °C
Protection class	II according to EN 60335	II according to EN 60335	II according to EN 60335
Protection type	IP 40	IP 40	IP 40
Installation	Surface or over mechanism box	Surface or over mechanism box	On wall (horizontal or vertical)
Accessories	-	-	TX ATHENA, X CODE WAVE, X CODE GSM, MA 16, XR1 8A.

### Connection diagram

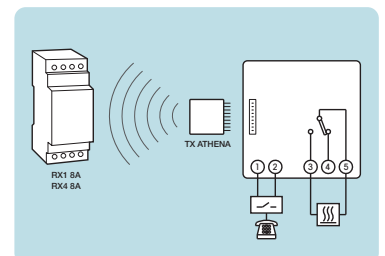
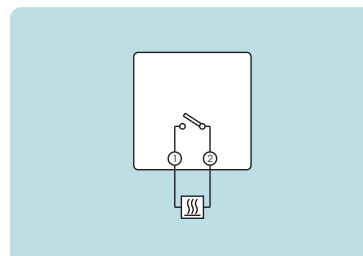
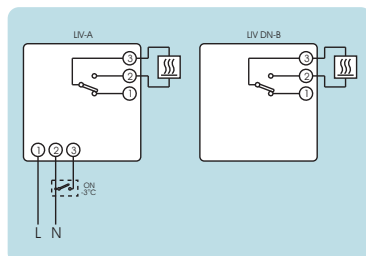

### Dimensions

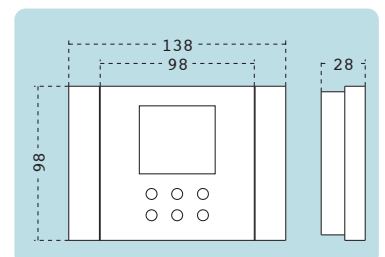
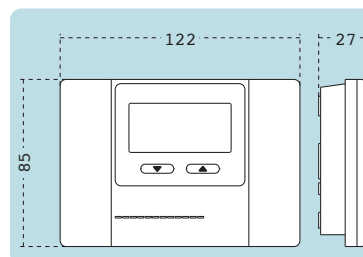
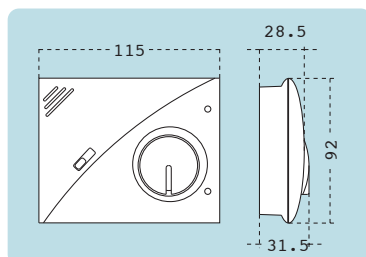



# CRONOTHERMOSTATS

## ERA



## VIA



## NEO



## THERMO X



### Description

Cronothermostat to control air conditioning or heating installations. ANALOG (ERA) or digital versions. It admits phone controllers (X.CODE GSM or X.CODE WAVE). NEO and VIA are available in different colours (black, white and aluminium).

### Features

<b>Rated voltage</b>	2 alkaline batteries 1, 5 V AA (LR06)	2 alkaline batteries 1, 5 V AAA (LR03)	2 alkaline batteries 1, 5 V AAA (LR03)	2 alkaline batteries 1, 5 V AA (LR06)
<b>Battery substitution time</b>	-	10 minutes	10 minutes	-
<b>Switching capacity</b>	5(1) A 250 Va.c.	5(1) A 250 Va.c.	5(1) A 250 Va.c.	8 A - 250 Va.c.
<b>Contact</b>	Changeover	Changeover	Changeover	Changeover
<b>Battery life</b>	1 year approximately	1 year approximately	1 year approximately	2 years approximately
<b>Minim. programmable time</b>	15 min. (Daily) / 2 h. (Weekly)	1 hour	30 min.	1 hour
<b>Temperature accuracy</b>	± 1 °C	± 0, 5 °C	± 0, 5 °C	± 0, 5 °C
<b>Resolution</b>	-	0, 1 °C	0, 1 °C	0, 1 °C
<b>Temperature measurement period</b>	1 minute	1 minute	30 s	-
<b>Output relay updating</b>	1 minute	1 minute	1 minute	-
<b>Programming type</b>	Daily	Weekly 8 programs / 2 temperatures + Anti ice	Weekly 8 programs / 2 temperatures + Anti ice	Weekly with 7 daily programs/ 3 temperatures
<b>Temperature range</b>	10 °C to 40 °C (Comfort) 0 °C to 25 °C (Saving)	15 °C to 35 °C (Comfort) 5 °C to 25 °C (Saving)	0 °C to 50 °C (with internal probe) -10 °C to +50 °C (with external probe)	2 °C to 35 °C (heating: automatic/manual) 10 °C to 35 °C (air conditioning: automatic/manual)
<b>Operating temperature</b>	-10 °C to 45 °C	0 °C to 50 °C	0 °C to 50 °C	0 °C to 50 °C
<b>Operating accuracy</b>	-	≤ ± 1, 2 s. / 24 h to 23°C	≤ ± 1, 2 s. / 24 h to 23°C	≤ ± 1, 2 s. / 24 h to 23°C
<b>Protection class</b>	II according to EN 60335	II according to EN 60335	II according to EN 60335	II according EN 60335
<b>Protection type</b>	IP 40	IP 40	IP 40	IP 40
<b>Installation</b>	Surface	Surface or over mechanism box	Surface or over mechanism box	Surface or over mechanism box
<b>Accessories</b>	-	X CODE WAVE, X CODE GSM, MA 16.	X CODE WAVE, X CODE GSM, MA 16, X TEMP.	X CODE WAVE, X CODE GSM, MA 16, X TEMP

### Connection diagram

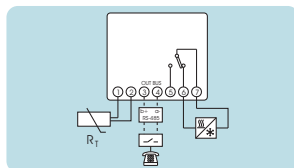
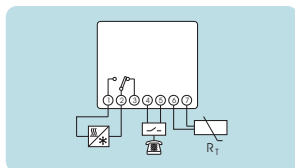
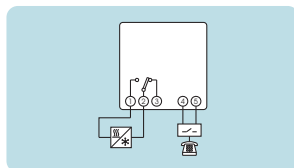
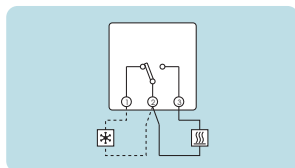

### Dimensions

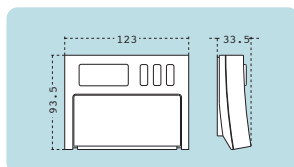
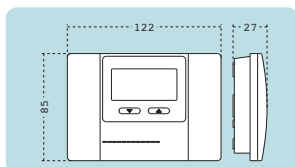
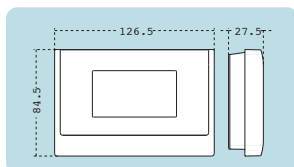
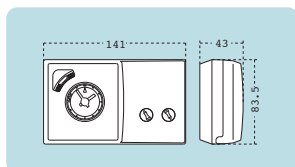

## ATHENA



## NEO<sup>RF</sup> / KIT ACCLIMATIZATION



### Description

ATHENA enables the acclimatization control for up to four different areas by means of extra probes (ATHENA TEMP) connected by BUS cable. It can be connected without cables (TX ATHENA) with the actuator RX4 8A; admits phone controller (X.CODE WAVE or X.CODE GSM).

The NEO<sup>RF</sup> kit is the easiest way to control the acclimatization by means of a wireless solution. It is made up of a plug in actuator for the heater, a NEO<sup>RF</sup> cronothermostat and an optional external probe.

### Features

Rated voltage	2 alkaline batteries 1, 5 V AAA (LR03)	2 alkaline batteries 1, 5 V AAA (LR03)
Battery substitution time	2 minutes	10 minutes
Switching capacity	8 A / 250 Va.c.	5(1) A 250 Va.c.
Contact	Changeover	Changeover
Battery life	1 year approximately	1 year approximately
Minimum programmable time	30 min.	30 min.
Temperature accuracy	± 0, 5 °C	± 0, 5 °C
Resolution	0, 1° C	0, 1 °C
Temperature measurement period	30 seconds	30 seconds
Output relay updating	-	1 minute
Programming type	Weekly with 7 daily programs/ 4 temperatures	Weekly with 8 daily programs/ 2 temperatures + anti ice
Temperature range	2 °C to 35 °C approx.	0 °C to 50 °C (internal probe) -10 °C to +50 °C (external probe)
Operating temperature	0 °C to 50 °C approx.	0 °C to 50 °C
Protection class	II according to EN 60335	II according to EN 60335
Protection type	IP 40	IP 40
Installation	Surface or over mechanism box	Surface or over mechanism box
Accessories	X CODE GSM, X CODE WAVE, MA 16, X TEMP, TX ATHENA, ATHENA TEMP, RX1 8A, RX4 8A	-

### Connection diagram

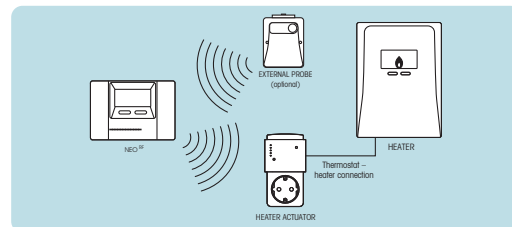
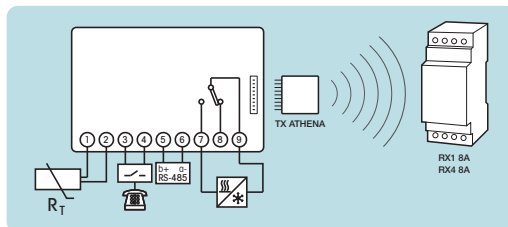

### Dimensions

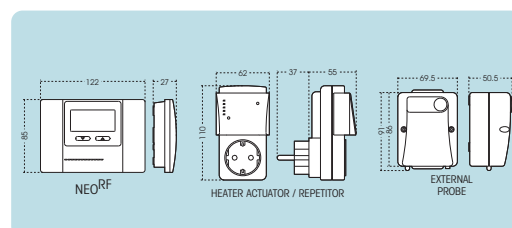
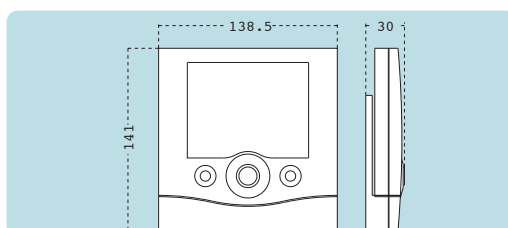

# TELEPHONE CONTROLLERS

## X.CODE WAVE



## X.CODE GSM



## MA 16



## CODITEL



### Description

They enable to act in the acclimatization installation by means of mobile or land telephone line.

### Features

Definition	X.CODE WAVE	X.CODE GSM	MA 16	CODITEL
Definition	Device for the ON/OFF remote control by means of land telephone line.	GSM telephone controller for the ON/OFF control by means of SIM card. It is possible a BUS connection with the cronothermostat for individual areas control	Connected with X.CODE GSM, X.CODE WAVE and CODITEL it enables controlling loads up to 16 A. It turns on or off and it answers with the state of the contact	CODITEL is a telephone remote controller whose main difference is that it reacts to missed call, so the activation or deactivation of any electrical device is free. This means that the mobile phone acts like a remote control. The activation time of the relay is adjustable meaning the unit can easily be configured for operating garage doors and gate openers (which are some of the most common applications) which allows you to add the unit to an existing installation with existing remote controllers, giving the user the option of using their phone or remote control to operate the system.
Features	Rated voltage: 230 Va.c. / 50 Hz 1 output relay (0,5 A – 125 Va.c.). For 16 A use MA16. ON/OFF manual control and indicator led. Telephone cable included to connect with the telephone line. Mounting on surface or over mechanism box.	Rated voltage: 230 Va.c. / 50 Hz 1 output relay (5 A – 230 Va.c.). For 16 A use MA16. Manual control ON/OFF and indicator led. Mounting on surface or over mechanism box	Rated voltage: 250 Va.c. (-15% / +10%) Output: mechanic relay 16 A / 250 V with contact "Normally Close" (NC). DIN rail mounting.	CODITEL turns ON, OFF, ON timing, OFF timing or relay state change by means of missed calls or SMS. CODITEL can also send a SMS answering the state of the installation. It is possible to add up to 100 different users

### Connection diagram

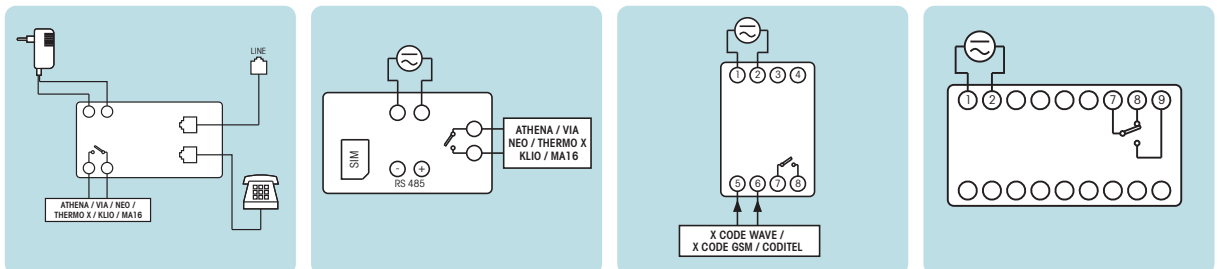

### Dimensions

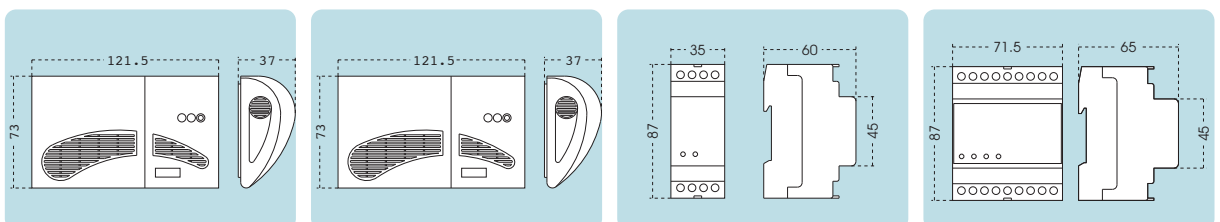

## TX ATHENA



## ATHENA TEMP



## RX1 8A



## RX4 8A



### Features

<b>Definition</b>	It converts the thermostat KLIO or the cronothermostat ATHENA in wireless transmitters.	Programmable temperature probe used to control different areas by means of ATHENA.	Waves actuator with one output, for KLIO or ATHENA. It receives the TX ATHENA signal. RX.ANT antenna included.	Waves actuator with four outputs for ATHENA. It receives the TX ATHENA signal. RX.ANT antenna included.
<b>Rated voltage</b>	-	Alkaline batteries 1, 5 V AAA (LR03).	230 Va.c.	230 Va.c.
<b>Output control</b>	-	-	1 Changeover relay 8 A/250 Va.c.	3 Changeover relays and 1 NA relay 8 A / 250 Va.c.
<b>Installation</b>	Inserted into KLIO or ATHENA.	Surface	DIN rail	DIN rail

### Connection diagram

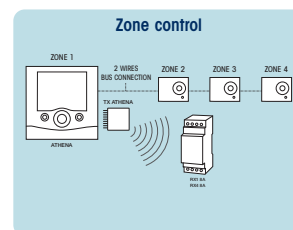
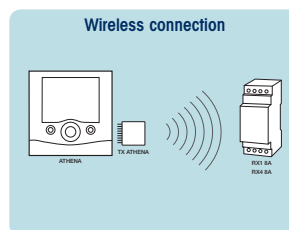
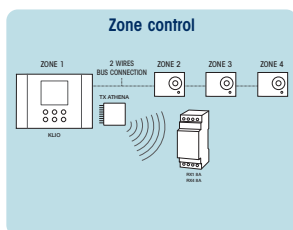
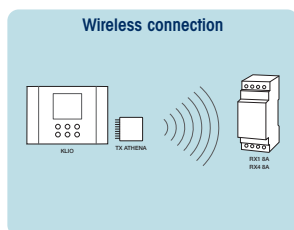

## RX.ANT



## X. TEMP



### Features

<b>Definición</b>	External antenna for RX1 8A or RX4 8A.	External probe for THERMO X, NEO, ATHENA.
<b>Frequency</b>	433, 92 ±10 MHz.	-
<b>Impedance</b>	50 Ω	-
<b>Cable length</b>	4, 5 meters.	2 meters (up to 40 meters) and 1mm <sup>2</sup> .
<b>Operating temperature</b>	-	-40 °C to +60°C
<b>Protection class</b>	-	IP 66



# GAS DETECTOR

## TWIST



### > Description

TWIST is a wall mounted gas detector by means of catalytic sensor. The TWIST gives an acoustic and visual warning of any gas leaks. TWIST also has an internal relay which can be connected to a normally open "NO" or normally closed "NC" shut off valve relay in order to cut off the flow of gas once a leak has been detected.

### > Functioning

- Auto check with fault indication.
- The unit activates when it detect a gas concentration of 10% of the L.E.L. (Lower Explosive Limit).
- After powering up the gas detector, there is a 1 minute delay before the system is active.
- After detecting gas for a 20 seconds period, the acoustic alarm and shut OFF valve relay are activated.

### > Kit Twist + Shut Off Valve Relay

- Gas detector TWIST.
- Shut OFF valve normally open suitable for 1/2" or 3/4" pipe. (Consult for other contact configuration or different pipe).

### > TWIST

Product code	Model
OB514410	TWIST METHANE-TOWN GAS
OB514510	TWIST GLP (Propane, butane)
OB514610	TWIST CO (Check availability)

### > KIT TWIST + ELECTROVALVE

Product code	Model
OB515212	KIT GAS METANE-TOWN GAS 1/2"
OB515312	KIT GAS GLP (Propane, butane) 1/2"
OB515234	KIT GAS METANE-TOWN GAS 3/4"
OB515334	KIT GAS GLP (Propane, butane) 3/4"

### > Features

Power supply	230 Va.c. 50 Hz
Capacity of contacts	Changeover 2, 5 A / 230 V
Absorption	20 mA max (methane/GPL)
Operating temperature	-5°C to +40°C
Relative humidity	-30% -90%
Acoustic signal	85 dB (A) to 1m.
Type of protection	IP 42
Installation	Wall or box mounting

### > Dimensions

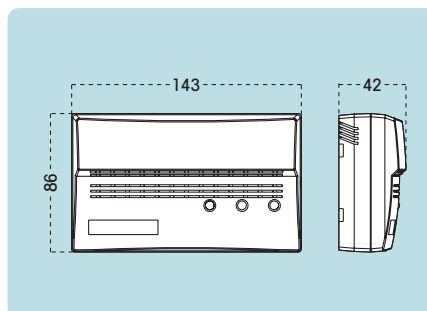

### > Connection diagram

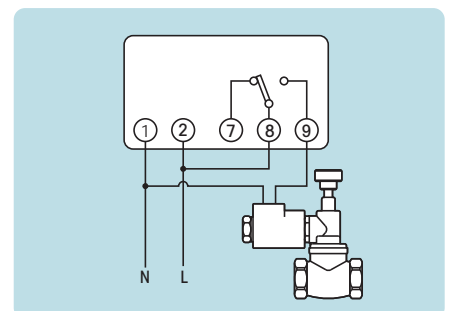

# TWILIGHT SWITCHES

## VEGA



## DOMOLUX



## ORBIFOT



### > Description

ON and OFF switching controllers according to the luminosity level, it is used in lighting installations such as shop windows, doorways, signalling, neon signs, etc.

### > Features

<b>Rated voltage</b>	230 Va.c.	230 Va.c.	230 Va.c.
<b>Frequency</b>	50 Hz	50-60 Hz	50 Hz
<b>Switching capacity</b>	10 A / 230 Va.c. $\cos \varphi = 1$	10 A / 230 Va.c. $\cos \varphi = 1$	10 A / 250 Va.c.
<b>Own consumption</b>	8 VA (1 W approx.)	3, 4 VA (0, 7 W approx.)	8 VA (1 W approx.)
<b>Contact type</b>	Single with voltage	Single with voltage	Single without voltage
<b>Maximum recommended loads</b>			
Incandescent	2000 W	2250 W	800 W
Non-compensated fluorescent	200 W	2300 W	360 W
Fluorescents	200 W	700 W 64 $\mu$ F	By means of contactor
Low voltage halogen	500 VA	2000 VA	600 VA
Halogen (230 Va.c.)	1000 W	2250 W	800 W
Low consumption lamps	200 W	400 W	By means of contactor
<b>Sensor type</b>	Cadmium Sulphurate	Cadmium Sulphurate	Cadmium Sulphurate
<b>Operating temperature</b>	-30 °C to +50 °C	-25 °C to +45 °C	-10 °C to +50 °C
<b>Sensitivity</b>	5-300 lux logarithm	5-200 lux	5-1000 lux logarithm
<b>ON/OFF delay</b>	60 s / 60 s	30 s / 30 s	25 s / 25 s
<b>Protection type</b>	IP 54	IP 55	IP 65
<b>Installation</b>	Surface or post	Surface or post (fastened by clamp)	Surface or over lamp post

### Connection diagram

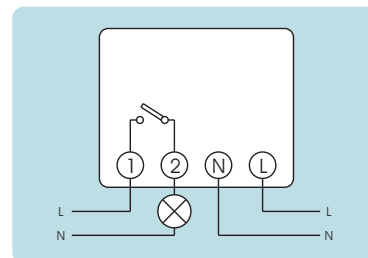
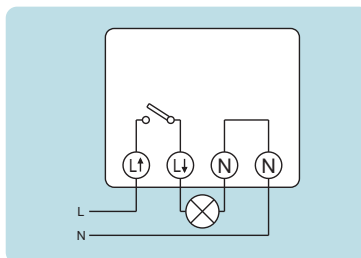
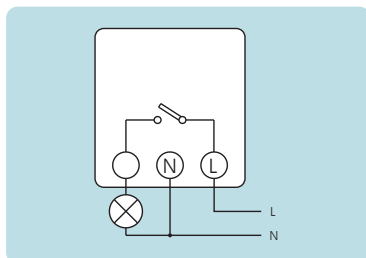

### Dimensions

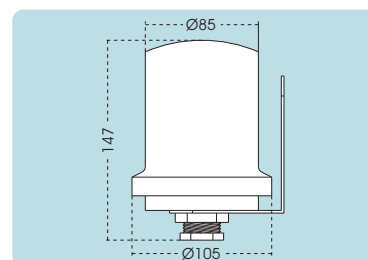
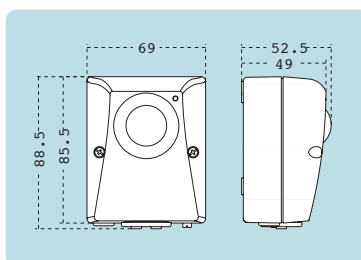
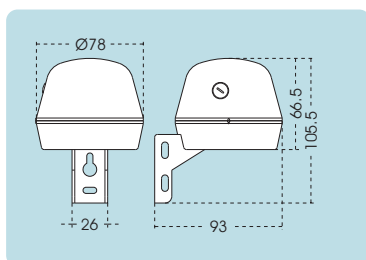

# ASTRONOMIC SWITCHES

## ASTRO



## DATA ASTRO



## ASTRO LOG



## ASTRO NOVA CITY



### Description

Electronic time switch for street light control. Daily automatic adjustment of the sunset and sunrise hour along of the year. Time setting by introducing the geographic coordinates (longitude and latitude) and the time. Useful for street lighting control, shops windows lighting, neon signs, illuminated fountains, ornamental lighting, etc. Maintenance free.

### Features

<b>Rated voltage</b>	120 or 230 Va.c. / 50-60 Hz	230 Va.c. / 45-60 Hz	230 Va.c. / 50-60 Hz	230 Va.c. / 50-60 Hz
<b>Switching capacity</b>	2x10(2) A / 250 Va.c.	2x10 (2) A / 250 Va.c.	2x16 (10) / 250 Va.c.	2x16 (10) / 250 Va.c.
<b>Contact type</b>	Automatic: single with voltage Voluntary: changeover without voltage	Changeover without voltage	Changeover without voltage	Changeover without voltage
<b>Own consumption</b>	15 VA	5 VA (1W approx.)	6 VA (1W approx.)	6 VA (1W approx.)
<b>Accuracy</b>	± 0, 5 s/day between 20 °C and 30 °C	± 1 s/day between 20 °C and 30 °C	± 1s/day to 23°C	± 1s/day to 23°C
<b>Battery back up</b>	≥ 12 years without power supply to 23 °C	≥ 30 days after 48 h. connected to the power supply uninterrupted	≥ 4 years without power supply (Lithium)	≥ 4 years without power supply (Lithium)
<b>Maximum recommended loads</b>				
Incandescent	-	2000 W	3000 W	3000 W
No compensated fluorescent	-	500 W	1200 W	1200 W
Fluorescents	-	By means of contactor	1200 W 150 µF	1200 W 150 µF
Low voltage halogen	-	1500 VA	1000 VA	1000 VA
Halogen (230 Va.c.)	-	2000 W	2500 W	2500 W
Low consumption lamps	-	By means of contactor	10x23 W	10x23 W
<b>Memory spaces</b>	-	104	22	22
<b>Application area</b>	Iberian Peninsula and Canary Island	Europe	Worldwide	Spain and Portugal / Algeria, Belgium, France, Luxemburg, Morocco and Tunisia / Denmark, Finland, Norway and Sweden / Italy / German / England / Poland.(Booking query for other countries)
<b>Automatic s/w change</b>	Yes	Yes	Yes	Yes
<b>Installation</b>	Surface (Fastening triangle)	DIN rail	DIN rail	DIN rail
<b>Protection type</b>	IP 52	IP 20	IP 20	IP 20
<b>Connection diagram</b>				

### Dimensions

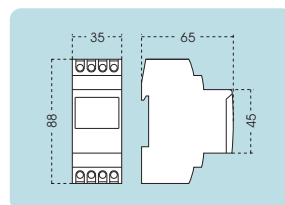
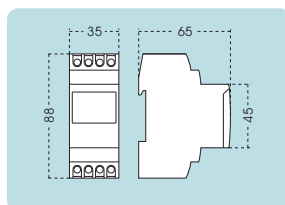
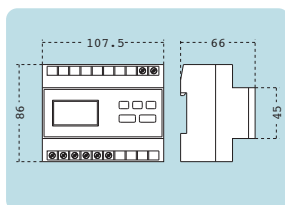
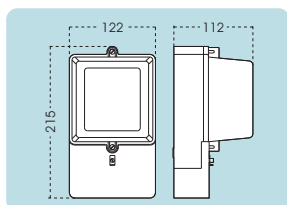



## ESDONI



### Description

ESDONI equipment is a line-head flux stabiliser-reducer that resolves problems caused by grid instability by stabilising line supply voltage during peak periods. They reduce the voltage during off-peak periods and thus achieve additional savings.

Lighting systems that incorporate discharge lamps associated with ballast of the high-pressure sodium vapour (HPSV) type or mercury vapour (MV) are highly susceptible to supply voltage variations.

Voltages exceeding 105% of the rated value for which they were designed will significantly reduce lamp and equipment life span by increasing electric power consumption.

The graph in Figure 1 shows the great influence of power supply voltage on consumption and on the lifespan of a 400W HPSV lamp. As can be seen, a 7% increase produces a lifespan reduction of 50% and a 16% excess consumption.

In addition, the need to rationalise energy consumption leads to the reduction of public street lighting levels during hours when there are fewer users.

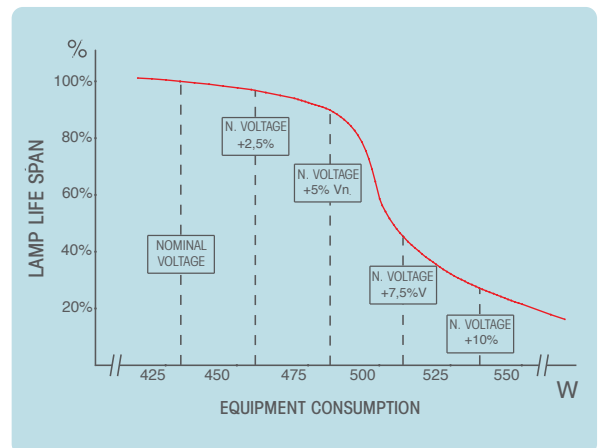
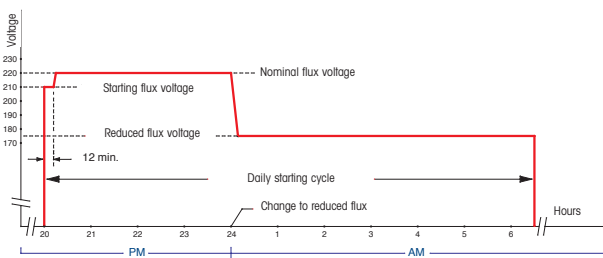

Fig.1: Lamp life span and consumption in function of mains voltage. (Auxiliary equipment - series ballast - 400 W high-pressure sodium vapour)

### Funciones Básicas

- Limiting the current peak when the lamps are switched on.
- Stabilising the lighting line rated voltage.
- Reduce the lighting line voltage during the hours of fewest users.

### Operation graphic



Equipment start-up regime curve, rating, and reduced until sunrise of the ESDONI equipment.

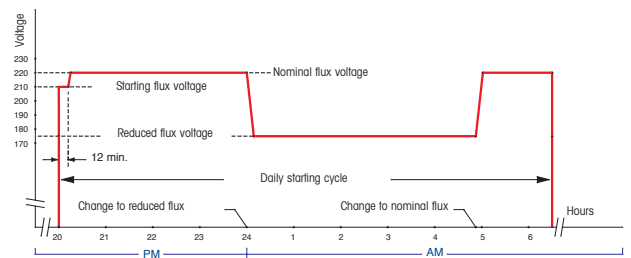

Start-up regime curve, rating, reduced and return to the rating regime of the ESDONI equipment.

# LIGHT FLOW STABILIZERS-DIMMERS

## ESDONI-EN



Features	EN10	EN20	EN30	EN40	EN50
System	Static	Static	Static	Static	Static
Power (kVA)	10	20	30	40	50
Power supply (V)	3 x 400 + N	3 x 400 + N	3 x 400 + N	3 x 400 + N	3 x 400 + N
Admissible variation (V)	± 7%	± 7%	± 7%	± 7%	± 7%
Rated mode (V)	220/215/210	220/215/210	220/215/210	220/215/210	220/215/210
Regulation	±1%	±1%	±1%	±1%	±1%
Start-up mode (V)	210	210	210	210	210
R. HPSV mode (V)	175/185	175/185	175/185	175/185	175/185
Maximum reduction	Input V – 25%	Input V – 25%	Input V – 25%	Input V – 25%	Input V – 25%
R. VM mode (V)	195/205	195/205	195/205	195/205	195/205
Equipment I <sub>max</sub> (A)	3 x 15 = 45	3 x 30 = 90	3 x 45 = 135	3 x 60 = 180	3 x 75 = 225
Phase I <sub>max</sub> (A)	15	30	45	60	75
Weight (Kg with polyester box)	110	125	160	190	210
Weight (Kg with metallic box)	120	135	170	200	220
Weight (Kg chassis)	80	95	130	160	180

### Dimensions

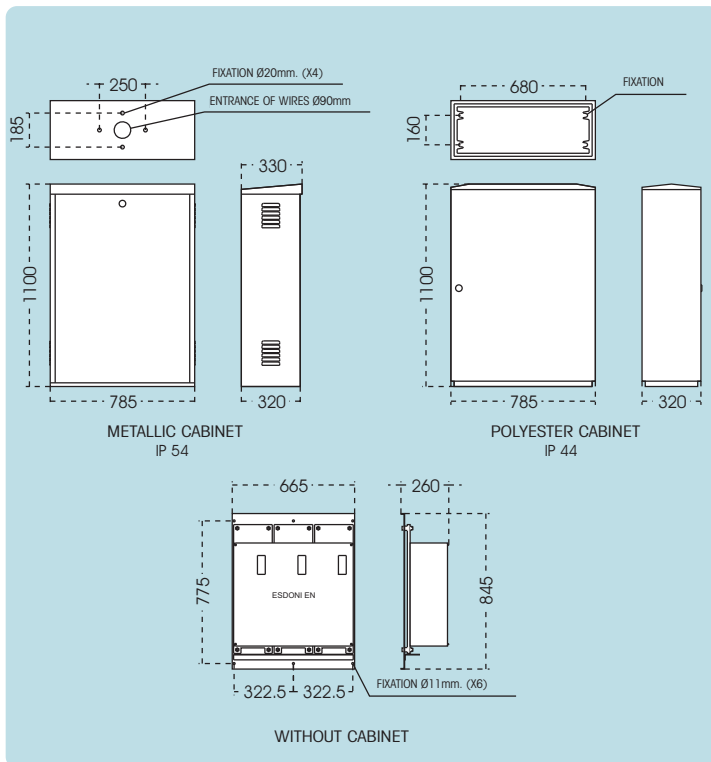

### Connection diagram

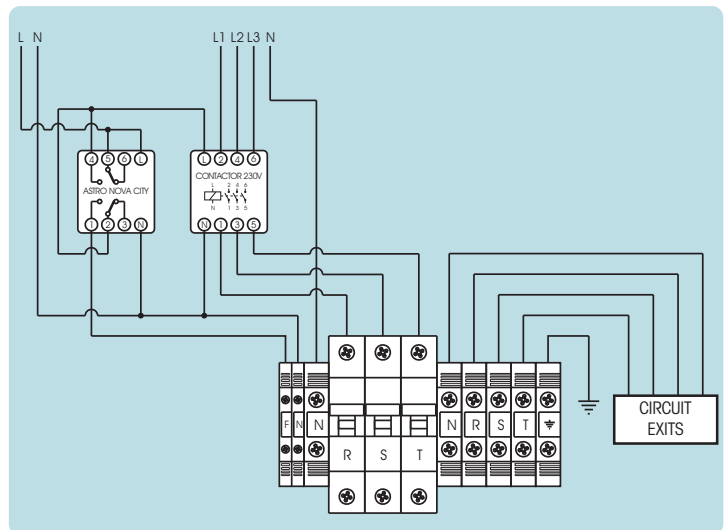

# SINGLE PHASE LIGHT FLOW STABILIZERS-DIMMERS

## ESDONI-M

### Description

The ESDONI-M models are presented as the solution for savings by flux stabilisation and reduction in single-phase public lighting installations. They perform the same functions as the ESDONI-EN equipment for powers of up to 16.6 kVA. Its application is ideal for installations such as sports centre tracks, office building exterior lighting, small gardens and urbanisations etc.



### Features

	M3	M6	M10	M16
System	Static	Static	Static	Static
Power (kVA)	3,3	6,6	10	16,6
Power supply (V)	230	230	230	230
Admissible variation (V)	± 7%	± 7%	± 7%	± 7%
Rated mode (V)	220/215/210	220/215/210	220/215/210	220/215/210
Regulation	±1%	±1%	±1%	±1%
Start-up mode (V)	210	210	210	210
R. HPSV mode (V)	175/185	175/185	175/185	175/185
Maximum reduction	Input V – 25	Input V – 25	Input V – 25	Input V – 25
R. VM mode (V)	195/205	195/205	195/205	195/205
Equipment I <sub>max</sub> (A)	15	30	45	75
Weight (Kg with polyester box)	46	51	63	79
Weight (Kg with metallic box)	60	65	75	95

### Dimensions

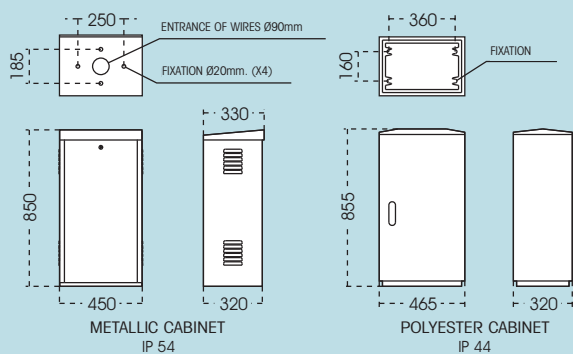

### Connection diagram

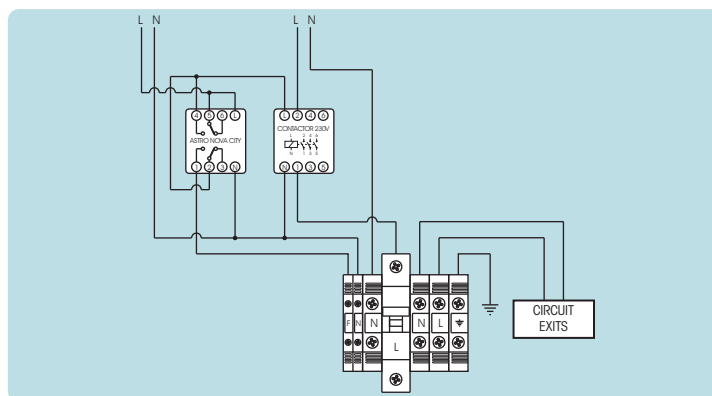

## LIGHT FLOW STABILIZERS-DIMMERS ACCESORIES

### Control Auxiliary ARL

Public lighting installations comprise equipment with HPSV or MV lamps. Equipment with series ballast and HPSV lamps can be regulated and their power reduced to 40% of the rated value. Equipment with MV lamps and series ballast can be reduced to 25% of their rated power value. Reductions of below 195 V produce switch off.

The regulation auxiliaries allow voltage to be reduced to 175 V without any undesired switch-off or instability and can produce savings of up to 35% with VM lamps for voltage values of 175V. The incorporation of regulation auxiliaries can produce similar savings figures with HPSV and MV lamps in installations sharing both types or only with MV lamps.

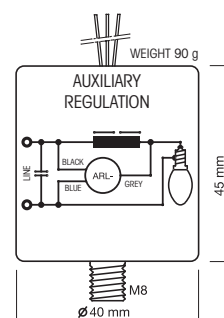

## ORBICOM / NODITEL



### Description

The remote management system for electrical boards is a product designed to perform the functions of measurement analyser and fault detection, together with their remote management via GSM communications, thus supplementing the ESDONI flux stabilisers-reducers equipment offer. Its main goal is to have the main lighting board parameters available from a central post and mobile units, together with certain situations that could require immediate technical assistance or awareness, such as protection trips, board opening, wiring theft and lamp replacement.

The remote management system consists of two main equipment units:

A master designated ORBICOM is responsible for carrying out electrical measurements, providing direct information on its display and establishing communications; and also several slave nodes designated NODITEL that are connected to the various board lines and which monitor operations and their protections and continually transmit operating and anomaly information to the master.

### Example of controlling by means of ORBICOM

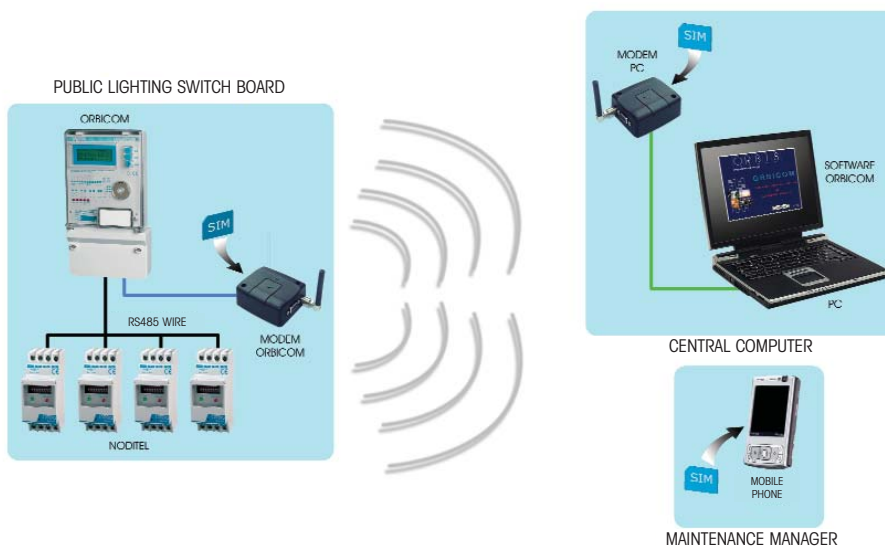

### Software

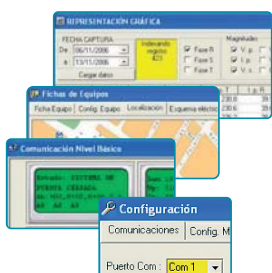

In order to obtain enhanced control of the installations that are fitted with ORBICOM equipment, a GSM modem may be connected to this, which will send information to a central computer as well as to the various maintenance teams' mobile telephones via SMS.

Commands can be sent to the installations at the same time as alarms and information are being issued from them.

In order to better define the parameters required by each maintainer, such as alarms, load curves and SMS etc., a control software is available that allows: the creation of an independent file per board / display reading in local or remote / command transmission / the configuration of each ORBICOM / data and fault recording / graphical parameter display / astronomic or fixed lighting programming.

## ORBICOM

The master module, designated ORBICOM, is an autonomous element that is installed on the lighting board and which performs the following functions:

- It measures the line voltage in true r.m.s. value between each phase and neutral, reaches 255 V
- Maximum current: 80 A per phase.
- It will calculate the  $\cos \phi$  for each of the three phases.
- It will calculate the active power in each of the three phases, between each phase and neutral.
- It will calculate the total active power.
- It incorporates configurable astronomical switch on and switch off operations.
- It will measure the voltage in true r.m.s. value between each phase and neutral at the lighting line outputs, when installed with ESDONI equipment, reaches 255 V.
- It calculates the savings for each phase in %, when installed with ESDONI equipment.
- It calculates the total savings in % when installed with ESDONI equipment.
- Intruder, wiring theft and blown lamp alarms.
- Connection for up to 15 NODITEL units per RS-485 port.
- Direct event reading on the equipment display.
- Remote data transmission to a central unit over RS-232 modem, via GSM modem, telephone wires etc.
- Remote programming of switch on and switch off in astronomical or fixed mode.

### Features

Rated line voltage	3 x 230/400 Va.c.
Measured voltage	3 x 230 Va.c. + N
Maximum current per phase	80 A
Frequency	50 Hz
Own consumption	Approx. 20 VA
Battery back up	6 years using a lithium battery
Operational precision	< $\pm 0,5$ s/24 h to 23 °C
Operating temperature	-10 °C to + 45 °C
Precision accuracy class	Class 1 active power - Class 2 reactive power
Protection class	II adequate mounting
Protection type	IP 51
Mechanical strength	IK 06
Installation	Fastening triangle in surface according to DIN 43857

### Dimensions

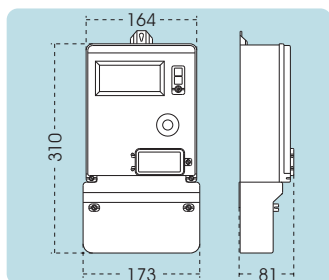

### Connection diagram

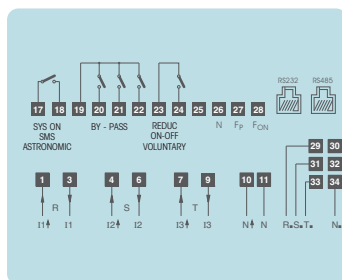

## NODITEL

Reduc on/off voluntario: ON/OFF Voluntary reduction. The nodes designated NODITEL are elements that are supplementary to the ORBICOM that enable system functions to be expanded, acquiring data and transmitting them to the master. Their most important specifications and functions are:

- Nodes that communicate with the ORBICOM via RS-485
- Detection of fuse, breaker earth-leakage breaker failures etc. (by detecting voltages of less than 160V r.m.s.)
- Each NODITEL includes DIP switches for address programming.
- The RS-485 can connect to a maximum of 15 NODITEL slaves.
- Direct power supply connection to the 230 V grid.
- When power is applied to the module, the green LED is switched on indicating power is present. If there are no problems, the Green LED will flash at a rate of 0.5 seconds ON/1 second-OFF.
- If the unit detects a problem, for example, a missing or low (less than 160 V) phase, the red LED ROJO will flash at a higher rate (0.1 seconds Ton and 0.1 seconds Toff).
- Each module can detect the voltage in up to three phases in the same line, which is R, S and T with its neutral, or between phase and neutral in single-phase lines.

### Features

Rated line voltage	230 Va.c.
Measured voltage	3 x 230 Va.c. + N
Alarm voltage per phase	160 Va.c.
Frequency	50 Hz
Own consumption	Approx. 5 VA
Operating temperature	-10 °C to + 45 °C
Precision class	Class 1
Protection class	II adequate mounting
Protection type	IP 20
Mechanical strength	IK 02
Installation	DIN rail

### Dimensions

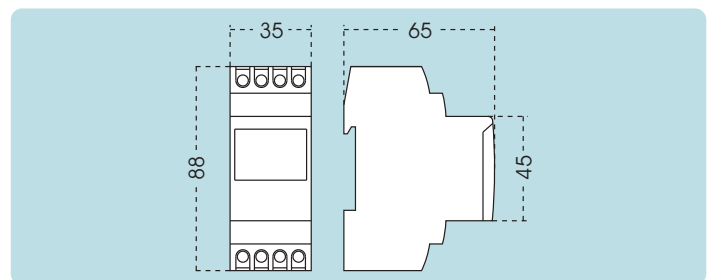

# DIGITAL VOLTMETERS / AMPMETERS AND FREQUENCYMETERS

## METRA Q-H METRA M-H



## METRA Q-A METRA M-A



## METRA Q-V METRA M-V



## METRA Q-V+A / METRA Q-V/A METRA M-V+A / METRA M-V/A



## METRA Q-V/A-R METRA M-V/A-R



### Description

FREQUENCYMETER

AMPMETER

VOLTMETER

VOLTMETER/ AMPMETER

VOLT./ AMPM. WITH RELAY

Measuring elements for electrical parameters, such as voltage, current and frequency. Installation either DIN rail or panel. For alternative or direct current, up to 4,000 amps via a current transformer

### Features

Rated voltage	115/230 Va.c. / 50-60 Hz	115/230 Va.c. / 50-60 Hz	115/230 Va.c. / 50-60 Hz	115/230 Va.c. / 50-60 Hz	115/230 Va.c. / 50-60 Hz
Transformers range selectable		METRA M-AxA: 5-10-25-50-60-100-125-150-200-250-300-400-500-600-800-1000-1500-2000-2500-4000/5 A		5-10-25-50-60-100-125-150-200-250-300-400-500-600-800-1000-1500-2000-2500-4000/5 A	5-10-25-50-60-100-125-150-200-250-300-400-500-600-800-1000-1500-2000-2500-4000/5 A
Operating temperature	-10 °C a +50 °C	-10 °C a +50 °C	-10 °C a +50 °C	-10 °C a +50 °C	-10 °C a +50 °C
Protection Type / Class	IP 40 / 2	IP 40 / 2	IP 40 / 2	IP 40 / 2	IP 40 / 2

### Models

H (Frequencymeter)

A (Ampmeter)

V (Voltmeter)

V+A (Voltmeter and Ampmeter)  
V/A (Voltmeter or Ampmeter)

V/A-R (Voltmeter or Ampmeter with programmable out put relay)

**Q**  
Panel model  
(72x72 mm.)\*

**METRA Q-H:**  
Accuracy 0,1 Hz.

**METRA Q-A 10A AC:**  
Up to 10 A a.c.  
Accuracy 10 mA. 72x72 mm.

**METRA Q-A 10A DC:**  
Up to 10 A a.c.  
Accuracy 10 mA. 72x72 mm.

**METRA Q-A xA:**  
Up to 4000/5 A a.c.

**METRA Q-V 1V DC:**  
Up to 1 Vd.c.  
Accuracy 1 mV. 72x72 mm.

**METRA Q-V 10V DC:**  
Up to 10 Vd.c.  
Accuracy 10 mV.

**METRA Q-V 100V DC:**  
Up to 100 Vd.c.  
Accuracy 0,1 V.

**METRA Q-V 600V DC:**  
Up to 600 Vd.c.  
Accuracy 1 V. 72 x 72 mm.

**METRA Q-V+A:**  
Voltmeter up to 600 Va.c. and amp meter by transformers

**METRA Q-V/A:**  
Voltmeter up to 600 Va.c. or amp meter by transformers.

**METRA Q-V/A-R:**  
600 Va.c. / Amp meter by transformers with programmable out put relay.

**M**  
Rail DIN model

**METRA M-H:**  
Accuracy 0,1 Hz.

**METRA M-A 10A AC:**  
Up to 10 A a.c.  
Accuracy 10 mA.

**METRA M-A 10A DC:**  
Up to 10 A a.c.  
Accuracy 10 mA. 72x72 mm.

**METRA M-A xA:**  
Up to 4000/5 A a.c.

**METRA M-V 1V DC:**  
Up to 1 Vd.c.  
Accuracy 1 mV.

**METRA M-V 10V DC:**  
Up to 10 Vd.c.  
Accuracy 10 mV.

**METRA M-V 100V DC:**  
Up to 100 Vd.c.  
Accuracy 0,1 V.

**METRA M-V 600V DC:**  
Up to 600 Vd.c.  
Accuracy 1 V.

**METRA M-V+A:**  
Voltmeter up to 600 Va.c. and amp meter by transformers. Modular.

**METRA M-V/A:**  
Voltmeter up to 600 Va.c. or amp meter by transformers. Modular.

**METRA M-V/A-R:**  
600 Va.c. / Amp meter by transformers with programmable out put relay.

### Dimensions

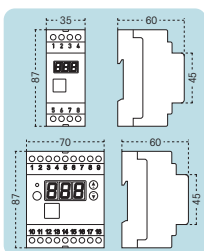
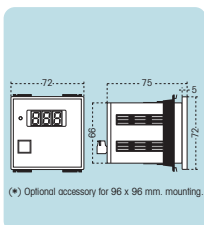

### Connection diagram

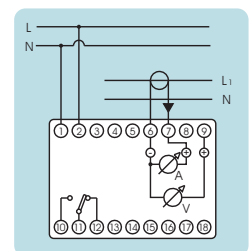
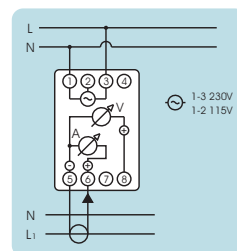
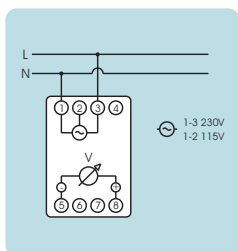
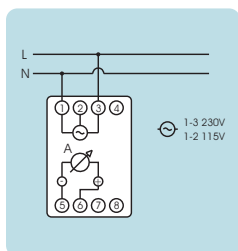
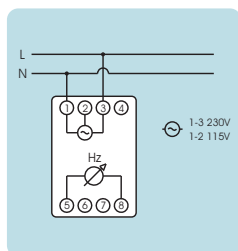
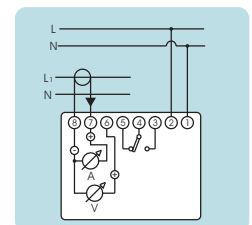
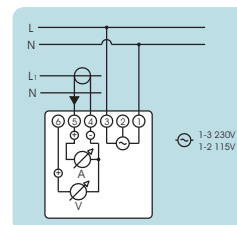
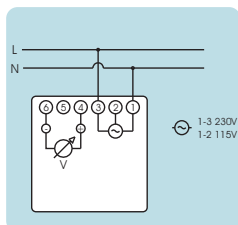
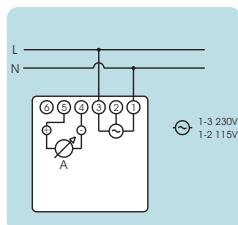
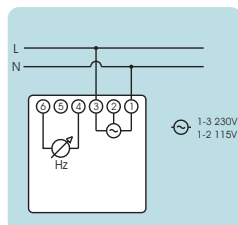

# MODULAR NET ANALIZER

## ANRET M-22



SINGLE PHASE 22A

## ANRET M-22-BUS



SINGLE PHASE 22A WITH COMMUNICATION BUS

## ANRET M-63



SINGLE PHASE 63A WITH PULSE OUTPUT

## ANRET M-90A-BUS



THREE PHASE 90A WITH COMMUNICATION BUS

### Description

Multi-function measuring elements for electrical parameters in single or three-phase systems. From 22 amps direct measurement up to 9,999 amps via a current transformer. Communication and DIN rail installation options

### Features

<b>Rated voltage</b>	230 Va.c. / 50-60 Hz	230 Va.c. / 50-60 Hz	230 Va.c. / 50-60 Hz	400 Va.c. / 50-60 Hz
<b>Intensity Input</b>	I <sub>b</sub> = 5A; I <sub>max</sub> = 22,5A direct connection	I <sub>b</sub> = 5A; I <sub>max</sub> = 22,5A direct connection or I <sub>n</sub> = 5A; I <sub>max</sub> = 6A by transformers x/5A.	I <sub>b</sub> = 10A; I <sub>max</sub> = 63A by cable pass	I <sub>b</sub> = 10A; I <sub>max</sub> = 90A by cable pass
<b>Transformers range selectable</b>		1 ... 9.999/5A		
<b>V max</b>	300 V	300 V	230 V	500 V
<b>Parameters</b>	- Voltage V (TRMS) - Current A (TRMS) - Power W - Power factor (cos φ) - Energy Wh - Frequency Hz	- Voltage V (TRMS) - Current A (TRMS) - Power W - Power factor (cos φ) - Energy Wh - Frequency Hz	- Voltage V (TRMS) - Current A (TRMS) - Power W - Power factor (cos φ) - Energy Wh - Frequency Hz	- Voltage V (TRMS) - Phase sequence - Current A (TRMS) - Active Power W - Reactive Power Var - Apparent Power VA - Active Energy Wh - Reactive Energy VAh - Power factor (cos φ) - Phase angle - Frequency Hz
<b>Display</b>	LCD, 7 + 5 digits retro illuminated screen	LCD, 7 + 5 digits retro illuminated screen	LCD, 7 + 5 digits retro illuminated screen	LCD retro illuminated screen
<b>Operating temperature</b>	-10 °C to + 45 °C	-10 °C to + 45 °C	-10 °C to + 45 °C	0 °C to + 45 °C
<b>Installation</b>	DIN	DIN	DIN	DIN
<b>Module numbers</b>	3	3	3	7
<b>Protection type</b>	IP 20	IP 20	IP 20	IP 20
<b>Protection class</b>	2	2	2	2
<b>Connection diagram</b>				
<b>Dimensions</b>				



# THREE PHASE NET ANALIZER

## ANRET Q ANRET M



BY TRANSFORMERS

## ANRET Q-BUS ANRET M-BUS



BY TRANSFORMERS WITH  
COMMUNICATION BUS

## ANRET Q-R ANRET M-R



BY TRANSFORMERS WITH  
2 OUTPUT RELAYS

## ANRET Q-MULTI ANRET M-MULTI



WITH MULTIPLE LED DISPLAY  
BY TRANSFORMERS

### Description

Multi-function measuring elements for electrical parameters in three-phase systems up to 9,999 amps via a current transformer. Communication, DIN rail and rear-board installation options.

### Features

<b>Rated voltage</b>	230 Va.c. / 50-60 Hz	230 Va.c. / 50-60 Hz	230 Va.c. / 50-60 Hz	115/230 Va.c. / 140/300V d.c. / 50-60 Hz
<b>Intensity Input</b>	I <sub>b</sub> = 5A; I <sub>max</sub> = 9999A by indirect connection	I <sub>b</sub> = 5A; I <sub>max</sub> = 9999A by indirect connection	I <sub>n</sub> = 5A; I <sub>max</sub> = 9999A by indirect connection	I <sub>n</sub> = 5A; I <sub>max</sub> = 9999A by indirect connection
<b>V max</b>	500 V	500 V	500 V	500 V
<b>Parameters</b>	- Voltage V (TRMS) – Sequence and phase - Current A (TRMS) – Active Power W – Reactive Power Var – Apparent Power VA – Active energy Wh – Reactive energy VARh – Power factor (cos φ) – Phase angle - Frequency Hz	- Voltage V (TRMS) – Sequence and phase - Current A (TRMS) – Active Power W – Reactive Power Var – Apparent Power VA – Active Energy Wh – Reactive Energy VARh – Power Factor (cos φ) – Phase angle - Frequency Hz	- Voltage V (TRMS) – Sequence and phase - Current A (TRMS) – Active Power W – Reactive Power Var – Apparent Power VA – Active Energy Wh – Reactive Energy VARh – Power Factor (cos φ) – Phase Angle - Frequency Hz	- Voltage V (TRMS) – Sequence and phase - Current A (TRMS) – Active Power W – Reactive Power Var – Apparent Power VA – Active Energy Wh – Reactive Energy VARh – Power Factor (cos φ) – Phase Angle - Frequency Hz
<b>Display</b>	LCD retro illuminated screen	LCD retro illuminated screen	LCD retro illuminated screen	LED
<b>Operating temperature</b>	-10 °C to + 45 °C	-10 °C to + 45 °C	-10 °C to + 45 °C	0 °C to + 45 °C
<b>Installation / Module numbers</b>	DIN / 3	DIN / 3	DIN / 3	DIN / 7
<b>Protection type / class</b>	IP 20 / 2	IP 20 / 2	IP 20 / 2	IP 20 / 2

### Dimensiones

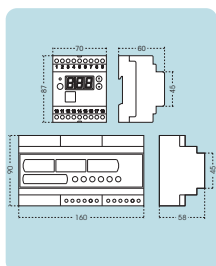
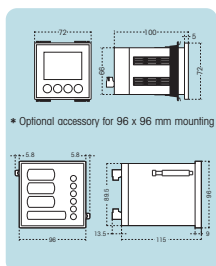

### Conexiones

